

expression

Lighting control system

Version 2.0

User manual

4030M1006 • *Revised 3/99*

Copyright Electronic Theatre Controls 1991, 1999

Limited warranty

Electronic Theatre Controls (ETC) warrants to the original owner or retail customer that for a period of one year from date of delivery of a portable system or energization of a permanently installed system (up to a maximum of 18 months from delivery) its products will be free from defects in materials and workmanship under normal use and service. Warranty is limited to 90 days for rental equipment.

Warranty does not cover any product or part of a product subject to accident, negligence, alteration, abuse or misuse or any accessories or parts not supplied by ETC. Warranty does not cover "consumable" parts such as fuses, lamps, color media or components warranted directly to the owner by the original manufacturer. ETC's warranty does not extend to items not manufactured by us. Freight terms on warranty repairs are FOB ETC factory or designated repair facility. Collect shipments or freight allowances will not be accepted.

ETC's sole responsibility under this warranty shall be to repair or replace at ETC's option such parts as shall be determined to be defective on ETC's inspection. ETC will not assume any responsibility for any labor expended or materials used to repair any equipment without ETC's prior written authorization. ETC shall not be responsible for any incidental, general or consequential damages, damages to property, damages for loss of use, time, profits or income, or any other damages.

The owner's obligations during the warranty period under this warranty are to notify ETC at ETC's address within one week of any suspected defect, and to return the goods prepaid to ETC at their factory or authorized service center.

THIS WARRANTY IS CONTINGENT ON THE CUSTOMER'S FULL AND TIMELY COMPLIANCE WITH THE TERMS OF PAYMENT SET FORTH IN THE "TERMS AND CONDITIONS". THIS WARRANTY IS EXPRESSLY IN LIEU OF ANY AND ALL OTHER WARRANTIES EXPRESSED OR IMPLIED INCLUDING THE WARRANTIES OF MERCHANTABILITY AND FITNESS FOR A PARTICULAR PURPOSE AND OF OTHER OBLIGATIONS AND LIABILITIES ON OUR PART. THE OWNER ACKNOWLEDGES THAT NO OTHER REPRESENTATIONS WERE MADE TO HIM OR RELIED UPON HIM WITH RESPECT TO THE QUALITY AND FUNCTION OF THE GOODS SOLD.

This written warranty is intended as a complete and exclusive statement of the terms thereof. Prior dealings or trade usage shall not be relevant to modify, explain or vary this warranty. Acceptance of, or acquiescing in, a course of performance under this warranty shall not modify the meaning of this agreement even though either party has knowledge of the performance and a chance to object.

table of contents

Chapter 1

Introduction	1 - 1
<i>Expression</i> features	1 - 2
Using this manual	1 - 3
Text conventions	1 - 5
Pile-on convention	1 - 5
Getting help	1 - 6
Customer service	1 - 6

Chapter 2

Installation	2 - 1
<i>Expression</i> back panel	2 - 2
Installing your console and monitor	2 - 3
Installing two monitors	2 - 4
Monitor connectors and pinouts	2 - 5
Monochrome monitors (RS-170)	2 - 5
Color RGB monitors	2 - 5
Entering system configuration	2 - 6
Installing dimmers	2 - 8
Digital outputs DMX512, ETC/LMI, D192 dimmers	2 - 8
Analog wire-per-dimmer output (optional)	2 - 8
Analog wire-per-dimmer input (optional)	2 - 9
AMX192 analog multiplex (optional)	2 - 9
Installing printer	2 - 10
Parallel printers	2 - 11
Serial printers	2 - 12
Installing Designer's Worksheet	2 - 13
Installing Remote Focus Unit	2 - 16
Installing Redundant Tracking Backup	2 - 17
Installing the alphanumeric keyboard	2 - 18
Installing Infrared Remote Focus Unit	2 - 19
Installing Remote Submasters and Macros	2 - 20

Chapter 3	
Entering softpatch and system settings	3 - 1
Entering softpatch	3 - 2
Entering one-to-one softpatch	3 - 3
Creating custom softpatch	3 - 4
Using channel zero	3 - 4
Entering numbers of channels and dimmers	3 - 5
Patching dimmers to channels	3 - 6
Additional patching features	3 - 8
Proportional patching	3 - 8
Dimmer profiles	3 - 9
Resetting factory dimmer profiles and all dimmers to default setting	3 - 10
Capturing channels in softpatch	3 - 10
Unpatching individual dimmers	3 - 11
Softpatching to a Strand CD80 dimmer rack	3 - 12
Entering system settings	3 - 13
Setting default full level	3 - 14
Setting default up and down fade times	3 - 14
Setting default fader clear times	3 - 15
Enable/disable bump switches	3 - 15
Enable/disable Flexichannel	3 - 16

Chapter 4	
Learning the basics	4 - 1
Lesson 1: Display, channel and record modes	4 - 2
Display modes	4 - 2
Stage, Blind and Fader screens	4 - 4
Channel modes	4 - 6
Captured channels	4 - 6
Selected channels	4 - 6
Recorded channels	4 - 7
Moving channels	4 - 7
Tracked channels	4 - 7
Record functions	4 - 8

Lesson 2: Working with cues	4 - 9
Creating cues	4 - 10
Cue 1: Creating a cue in Stage	4 - 11
Cue 2: Creating a cue in Blind	4 - 13
Cue 3: Modifying up and down fade times	4 - 15
Cue 4: Linking cues	4 - 17
Cue 5: Creating a cue using Solo	4 - 19
Inserting cues	4 - 21
Deleting cues	4 - 22
Viewing cues	4 - 23
Copying cues	4 - 24
Lesson 3: Playing back cues	4 - 25
Selecting cues	4 - 26
Timed faders and LED displays	4 - 26
Playing cues back	4 - 27
Go to a different cue	4 - 28
Controlling fades manually	4 - 29
Level override	4 - 30
Proportional rate override	4 - 30
Selecting fader operating mode	4 - 31
Manual control of linked cues	4 - 31
Modifying cues on stage	4 - 32
Update cue	4 - 33
Back key	4 - 34
Clearing fader pairs	4 - 35
Lesson 4: Working with submasters	4 - 36
Submaster pages	4 - 38
Creating pile-on submasters	4 - 39
Recording submaster on a different page	4 - 40
Adding fade times to submasters	4 - 41
Controlling submaster fades manually	4 - 42
Modifying pile-on submasters	4 - 42
Creating inhibitive submasters	4 - 43
Recording inhibitive submasters on a different page	4 - 45
Modifying inhibitive submasters	4 - 45
Using Update to modify submasters	4 - 46
Copying submasters	4 - 46
Deleting submasters	4 - 47
Submaster sheet	4 - 48

Lesson 5: Saving your show on disk	4 - 49
Naming shows	4 - 49
Formatting disks	4 - 50
Recording a show on disk	4 - 51
Verifying a show on disk	4 - 52

Chapter 5

Learning advanced techniques 5 - 1

Lesson 1: Working with multipart cues	5 - 3
Wait times in multipart cues	5 - 3
Creating a multipart cue	5 - 4
Converting a standard cue to a multipart cue	5 - 6
Editing a multipart cue	5 - 7
Lesson 2: Track record function	5 - 9
Using record to create tracks	5 - 10
Recording modified cues	5 - 11
Inserting cues	5 - 13
Blackout cues and tracking	5 - 15
Lesson 3: Track Sheet	5 - 17
Track Sheet screen	5 - 17
Track sheet description	5 - 18
Working with Track Sheet	5 - 19
Lesson 4: Using Group	5 - 21
Creating groups	5 - 22
Displaying groups on stage	5 - 22
Modifying groups	5 - 23
Modifying groups in Blind	5 - 23
Modifying groups in Stage	5 - 24
Modifying groups using Update	5 - 24
Deleting groups	5 - 25
Copying groups	5 - 26
Using groups to modify cues or submasters in Blind	5 - 27
Using Group Sheet to display groups	5 - 28

Lesson 5 : Working with effects	5 - 29
Creating an effect	5 - 30
Inserting and deleting steps	5 - 34
Editing steps	5 - 34
Effects shortcuts	5 - 35
Lesson 6: Working with subroutines	5 - 36
Styles	5 - 36
Creating subroutines.....	5 - 37
Deleting a step.....	5 - 40
Inserting a step	5 - 40
Lesson 7: Working with autoloads	5 - 43
Recording autoloads from Stage	5 - 44
Recording, previewing and modifying autoloads from Blind	5 - 45
Playing back autoloads.....	5 - 46
Lesson 8: Working with macros	5 - 47
Creating or modifying a macro	5 - 48
Using submasters in macros	5 - 50
Running a macro	5 - 50
Putting a macro on hold	5 - 50
Cancelling a macro	5 - 51
Deleting a macro	5 - 51
Sample macros	5 - 52

Chapter 6

Using print and disk options

Print options	6 - 2
Cues.....	6 - 3
Cue sheet	6 - 4
Designer's Worksheet	6 - 5
Groups	6 - 6
Group Sheet.....	6 - 7
Macros	6 - 8
Real time programs	6 - 9
Softpatch	6 - 10
Stage display.....	6 - 11
Submasters.....	6 - 12
Submaster Sheet	6 - 13
Track Sheet	6 - 14

Disk management	6 - 15
Storing disks	6 - 16
Formatting disks	6 - 16
Recording a show on disk	6 - 17
Reading a show from disk	6 - 18
Verify show on disk	6 - 19
Erase show from disk	6 - 20

Chapter 7

Accessories

Accessories	7 - 1
Alphanumeric keyboard	7 - 2
Naming cues, submasters and groups	7 - 3
Naming shows	7 - 4
Designer's Worksheet	7 - 5
Using the digitizer	7 - 6
Programming regions	7 - 7
Deleting regions	7 - 9
Infrared Remote Focus Unit (IRFU)	7 - 10
Remote Focus Unit (RFU)	7 - 12
MIDI	7 - 14
Interfacing with MIDI	7 - 15
Message formats	7 - 16
Message definitions	7 - 17
Real Time Clock	7 - 18
Creating or editing real time programs	7 - 18
Setting Real Time Clock	7 - 20
Serial Button Protocol	7 - 21
Redundant Tracking Backup	7 - 22
Remote Submasters and Remote Macros	7 - 24

Chapter 8

Reference

Reference	8 - 1
And	8 - 2
At	8 - 3
Autoload	8 - 4
Back	8 - 5
Black out	8 - 6
Blind	8 - 7
Bump switches	8 - 8
Captured channels	8 - 10

Chan	8 - 11
Clear	8 - 13
Clear fader	8 - 15
Clear show from memory	8 - 16
Cue	8 - 17
Delay time	8 - 20
Diagnostic system clear	8 - 21
Dim	8 - 22
Dimmer profiles	8 - 23
Effects keys	8 - 26
Enter	8 - 27
Except	8 - 28
Expand	8 - 31
Fader display	8 - 32
Fader wheel	8 - 33
Flash	8 - 34
Flexichannel	8 - 35
Full	8 - 36
Go	8 - 37
Grand Master	8 - 38
Group	8 - 39
Group Sheet	8 - 41
Help	8 - 42
Hold	8 - 43
Infinite wait times	8 - 44
Inhibitive submasters	8 - 45
Link	8 - 46
Macros	8 - 48
Minus (-)	8 - 49
Page	8 - 50
Patch	8 - 52
Plus (+)	8 - 53
Potentiometers (Pots)	8 - 54
Power	8 - 55
Rec	8 - 56
Record	8 - 57
Rel	8 - 58
Setup	8 - 59
Solo	8 - 60
Stage	8 - 62
Step/Part	8 - 63
Sub	8 - 64
Submaster Sheet	8 - 65
System Settings Menu	8 - 66

System setting options	8 - 67
Thru	8 - 68
Time	8 - 69
Timed fader pairs	8 - 70
Track	8 - 72
Track Sheet	8 - 73
Type	8 - 74
Update	8 - 75

Appendix A DIP switch settings	A - 1
---	-------

Appendix B Error messages	B - 1
--	-------

Appendix C Specifications	C - 1
--	-------

Index	I - 1
--------------------	-------

Appendix D Keyboard illustration	D - 1
---	-------

chapter 1

introduction

Welcome to ETC's *Expression*. ETC is excited about *Expression* and hopes you are as pleased with its performance as your audiences are with yours. This chapter includes information to orient you to the console and the manual. It includes the following sections:

- *Expression* features
- Using this manual
- Text conventions
- Pile-on convention
- Getting help
- Customer support

Expression features

Expression includes the following features:

- 24 manual faders that control programmed submasters.
- Two pages of submaster memories, each of which can hold up to 24 recorded submasters.
- 250 control channels.
- Proportional control channel softpatch that accommodates up to 512 dimmers (or 1,024 if you have the optional second DMX512 connector).
- 400 cue capacity per show.
- Disk drive used to store shows on 3.5-inch disks.
- Two independent, timed fader pairs used to play back recorded cues.
- Multipart cues, macros, subroutines, and effects to help automate complex tasks and key sequences.
- Support for optional features: Designer's Worksheet, Remote Focus Unit, MIDI, Real Time Clock, Serial Button Protocol, Redundant Tracking Mode, Infrared Remote Focus Unit, and Remote Submasters and Macros.

Optional expanded memory allows these additional features:

- Alphanumeric keyboard capability.
- Flexichannel display option.
- Group sheet.
- Submaster sheet.
- Expanded macro capacity.

Using this manual

This manual provides instructions for *Expression's* features and optional accessories. The following chapters are included:

<i>Chapter 1 Introduction</i>	<i>Expression</i> capabilities, console and manual conventions, getting help, and customer support.
<i>Chapter 2 Installation</i>	Instructions for installing <i>Expression</i> , monitor and optional accessories.
<i>Chapter 3 Entering softpatch and system settings</i>	Instructions for entering system settings that you are likely to change before using <i>Expression</i> for the first time or before beginning a new show.
<i>Chapter 4 Learning the basics</i>	Tutorial on working with cues and submasters, includes an overview of display, channel and control modes.
<i>Chapter 5 Learning advanced techniques</i>	Tutorial on working with more advanced <i>Expression</i> features including: multipart cues, track record function, Track Sheet, groups, autoloads, effects, subroutines, and macros.
<i>Chapter 6 Using print and disk options</i>	Instructions on using printer and disk options.
<i>Chapter 7 Accessories</i>	Instructions on using <i>Expression's</i> optional accessories.
<i>Chapter 8 Reference</i>	Description of console keys and menu options listed in alphabetical order.
<i>Appendix A DIP switch settings</i>	List of <i>Expression</i> DIP switch settings.

*Appendix B
Error messages*

List of *Expression* error messages and an explanation of each.

*Appendix C
Specifications*

Technical specifications for *Expression* console.

*Appendix D
Keyboard illustration.*

Pull-out illustration of *Expression* keyboard.

Text conventions

In this manual, console keys are indicated by square brackets, such as [Enter]. System messages are printed in boldface, such as **Select channel**. References to other sections of the manual are printed in italic, such as *Chapter 1, Introduction*.

Pile-on convention

Expression uses a pile-on convention rather than last-action convention to determine levels for channels that are acted on by several outputs. *Expression* reads all output levels it receives for a specific channel and sets that channel to the highest of these.

For example, assume a channel is included in a submaster. If a channel is also included in a cue that has played back and is in a fader, *Expression* sets the channel at the greater of the two settings.

The two exceptions to *Expression's* pile-on convention are channels captured by the keyboard or wheel and inhibitive submasters.

Captured channel settings override submaster and fader pair outputs. When you release captured channels, they return to their pile-on level.

The other exception to pile-on convention, inhibitive submasters, limit output levels from other submasters and timed fader pairs. Inhibitive submasters do not affect captured channel levels.

Getting help

Help screens are available for all *Expression* keys. To display help screens:

1. Press [Help].
2. Press any key on the console. *Expression* displays a description of the key you pressed. Help screens are not available for menu options.

Customer service

If you have problems with your console, please follow these steps:

1. Refer to the manual for instructions.
2. If you do not find the answer in the manual, call your local dealer or ETC for customer service. Please have the following information available before you call:
 - Console model and serial number (located on back panel)
 - Software version (displayed on boot screen)
 - Options installed
 - Dimmer installation type

To reach Electronic Theatre Controls' customer service department, call 608/831-4116 Monday through Friday, from 9:00 AM to 5:00 PM Central Standard Time. For emergency service after hours and weekends, call 608/831-4773. Your call will be answered electronically and automatically forwarded to a service representative who will contact you as soon as possible.

Address all correspondence about *Expression* to:

Electronic Theatre Controls
Customer Service Department
3030 Laura Lane
Middleton, WI 53562

chapter 2

installation

This chapter includes set up instructions that you need to install *Expression* and any optional accessories. *Chapter 3, Entering softpatch and system settings* includes instructions for entering the software settings that you will probably update before you begin a new show.

This chapter includes the following installation procedures:

- Installing your *Expression* console and monitor
- Entering system configuration
- Installing dimmers
- Installing printer
- Installing Designer's Worksheet
- Installing Remote Focus Unit (RFU)
- Installing MIDI
- Installing Redundant Tracking Backup
- Installing Infrared Remote Focus Unit (IRFU)
- Installing Remote Submasters and Macros
- Installing alphanumeric keyboard

An illustration of *Expression's* back panel is included on the next page. Operating instruction for optional accessories are included in *Chapter 7, Accessories*.

Expression back panel

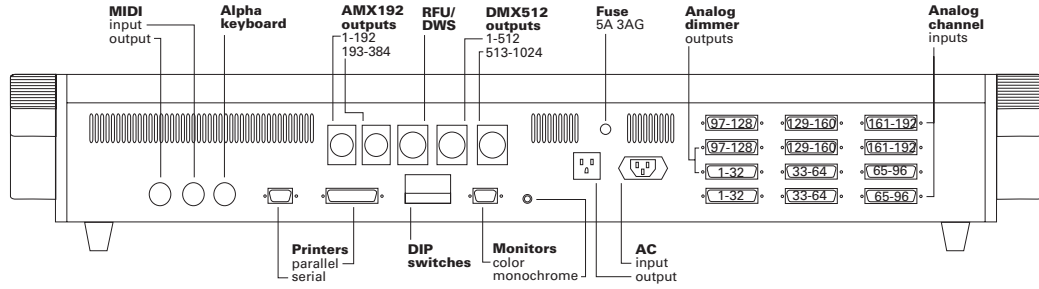

Installing your console and monitor

This section includes installation instructions for *Expression* and connector and pinout specifications for the monitor. Follow these steps to install your *Expression*:

1. Place console on a hard, stable, flat surface with at least 6 inches of space behind it for ventilation and cable clearance. Console should be at least 6 feet away from dimmers and high-current AC lines.

Caution: Do not leave the console in a road case tray or on a soft surface. This will inhibit proper ventilation.

2. Verify that your dimmer connector pinout is correct. Pinouts for several dimmer types are listed on pages 2 - 8 through 2 - 9. If your dimmer type is not listed, contact your dealer or ETC.

Caution: Your dimmer control common must be compatible with console control common; they must either be the same level, or the dimmer control common must float. Verify compatibility with your dealer if you are not sure.

3. Insert the key into the power switch, and turn it to the **Off** position.
4. Insert the female end of the power cord in the connector labeled **Power in** on the console's back panel.
5. Insert the male end of the console power cord in a grounded 120 VAC outlet. For 220 VAC operation, consult ETC.
6. Insert the female end of the monitor power cord in the monitor connector, and the male end of the monitor power cord in the console connector labeled **Power out**.

7. Insert the video cable in the monitor. Connect the other end of cable in the appropriate console connector listed below.

Digital RGB color monitors	DB-9 connector
Digital grayscale monitors	DB-9 connector
Composite monochrome monitors	BNC connector

8. Turn console and monitor power switches to their **On** positions.

Expression performs a series of self-tests and displays the options enabled on your console.

Installing two monitors

You may want to install two monitors at the same time, one next to the console and one at a remote location. Install one monitor using the color video connector, and the other using the monochrome video connector.

The color monitor should be located next to the console because the length of the color cable is limited to about 10 feet. The monochrome cable (RG59U) can be as long as 150 feet. Therefore, use the monochrome monitor at the remote location.

When you install both a monochrome and a color monitor, select monochrome monitor from the System Settings Menu as described on page 2 - 6.

Monitor connectors and pinouts

Monochrome monitors (RS-170)

Console connector

BNC female

Pinout

Center	Video
Shield	Common

Color RGB monitors

Console connector

DB-9 male

Pinout

- 1 Common (AC ground)
- 2 Common
- 3 Red
- 4 Green
- 5 Blue
- 6 Intensity
- 7 nc
- 8 Horizontal sync
- 9 Vertical sync

Entering system configuration

When you install your *Expression*, you have two system configuration options to set: monitor selection and boot option selection.

Expression retains these settings until you change them, you perform a diagnostic system clear, or the memory is corrupted.

Monitor selection

To configure your system for the type of monitor you have, follow these steps:

1. Press [Set Up] to display the Set Up Menu.
2. Select 6, **System Settings**, and press [Enter].
3. Select 11, **Color/monochrome monitor**, and press [Enter].
4. Select either 0 for a monochrome or grayscale monitor, or 1 for a color monitor.
5. Press [Enter].

Note: Some monitors may not be compatible with the console or may need special adjustment. If the picture breaks up, rolls or is not fully shown, check with your dealer for compatibility.

Boot option selection

Two system boot options are available, fast and full boot. The full boot performs a series of hardware tests. If the tests find any hardware problems, *Expression* displays a message indicating so. The fast boot option skips the hardware test and therefore boots faster.

Both boot options test the memory that holds show information. *Expression* displays a message during either boot option if it detects that the memory has been corrupted.

You will probably want to run the console with the fast boot option for convenience. However, you should select the full boot option periodically to run the console's hardware tests.

The boot option you select will perform tests the next time you turn console on. To select a boot option, follow these steps:

1. Press [Set Up] to display the Set Up Menu.
2. Select 6, **System Settings**, and press [Enter].
3. Select 12, **Full/fast boot test**, and press [Enter].
4. Enter 0 for full boot test or 1 for fast boot test. Then press [Enter].

Installing dimmers

To install dimmers, determine which of the following connectors are appropriate. Then insert dimmer cables in appropriate connectors. Dimmer connectors are illustrated on page 2 - 2.

Caution: Your dimmer control common must be compatible with console control common; they must either be the same level, or the dimmer control common must float.

Digital outputs DMX512, ETC/LMI, D192 dimmers

Connector

XLR 5-pin female
512 digital multiplex dimmers

Pinout

- 1 Common
- 2 Data (-) (DMX512, ETC/LMI, D192)
- 3 Data (+) (DM 512, ETC/LMI, D192)
- 4 Clock (+) (ETC/LMI only)
- 5 Clock (-) (ETC/LMI only)

Caution: If you do not use the ETC/LMI protocol, do not connect wires to pins four and five.

Analog wire-per-dimmer output (optional)

Connector

Centronics D36 female
3 connectors per 96 output card
6 connectors maximum, 192 dimmers

Pinout

Connector one	Pins 1-32 = dimmers 1-32
Connector two	Pins 1-32 = dimmers 33-64
Connector three	Pins 1-32 = dimmers 65-96
Connector four	Pins 1-32 = dimmers 97-128
Connector five	Pins 1-32 = dimmers 129-160
Connector six	Pins 1-32 = dimmers 161-192
All connectors	Pins 33-36 = common (Earth ground)

Analog wire-per-dimmer input (optional)

Connector

Centronics D36 male
 3 connectors per 96 input card
 6 connectors maximum, 192 dimmers

Pinout

Connector one	Pins 1-32 = dimmers 1-32
Connector two	Pins 1-32 = dimmers 33-64
Connector three	Pins 1-32 = dimmers 65-96
Connector four	Pins 1-32 = dimmers 97-128
Connector five	Pins 1-32 = dimmers 129-160
Connector six	Pins 1-32 = dimmers 161-192
All connectors	Pins 33-36 = common (Earth ground)

AMX192 analog multiplex (optional)

Connector

XLR 4-pin male
 192 dimmer outputs per connector
 384 outputs maximum, 2 connectors

Pinout

- 1 Common (Earth ground)
- 2 Clock (+)
- 3 Analog data
- 4 Clock (-)

Note: You can configure console for Strand CD80 Dimmer I and Dimmer II cabling convention. Contact an authorized dealer or ETC.

Installing printer

Expression supports both serial and parallel printers. Printer functions are described in *Chapter 6, Using print and disk options*. Pinout and connector specifications are on the next page. Follow these steps to install printer:

1. Parallel printers: Insert parallel printer cable into connector labeled **Parallel** on the back panel of the console.

Serial printers: Insert serial printer cable into connector labeled **Serial** on the back panel of the console. Set printer protocol at 1200 baud, 8 data bits, 2 stop bits, no parity.

2. Insert opposite end of printer cable into printer.
3. With the console on, press [Set Up].
4. Select 6, **System Settings**, and press [Enter].
5. Select 10, **Serial/Parallel Printer**, and press [Enter].
6. Enter 0 to select serial printer or 1 to select parallel printer, and press [Enter].
7. Turn printer power switch on, and verify that printer is on line.

Printer connectors and pinouts

Parallel printer and Centronics interface adaptor

Console connector

DB25F

Printer connector

Centronics D36

Pinout	Signal	Pinout
1	STRB	1
2	D0	2
3	D1	3
4	D2	4
5	D3	5
6	D4	6
7	D5	7
8	D6	8
9	D7	9
10	ACK	10
11, 12, 13	not used	11,12,18
14 to 25	nc	13 to 17, 19 to 36

Serial printers

Console connector		Printer connector	
DB9F		DB25M	
Pinout	Signal	Pinout	
2 _____	Data in _____	2 _____	(from printer)
3 _____	Data out _____	3 _____	(to printer)
5 _____	ground _____	7 _____	
8 _____	CTS* _____	20 _____	

Console connector pins 1, 4, 6, 7, and 9 are not used.

Printer connector pins 1, 4 through 6, 8 through 19, and 21 are not used.

* Clear to send (CTS) signal allows printer to interrupt the flow of data when printer's buffer is filled. Console only transmits data to printer when this line is held low (-12 VDC).

Installing Designer's Worksheet

Designer's Worksheet is one of the remote units available for use with *Expression*. Refer to Kurta digitizer tablet documentation if you need more information. Designer's Worksheet operation instructions begin on page 7 - 5.

Follow these steps to install your Designer's Worksheet:

1. Insert the 6-pin XLR connector of the Designer's Worksheet cable assembly into *Expression's* connector labeled **DWS/RFU**.
2. Insert the plug end of the pointing device (pen or stylus) in the worksheet connector labeled **Pen/Cursor**.
3. Attach the pen holder to the upper left or right hand corner of the worksheet by removing the protective paper from the base and pressing the adhesive to the tablet.
4. Place one printed template sheet under the clear plastic flap on the digitizer.
5. Set the voltage selection switch to match your electrical outlet. In the US, set the voltage switch to 110.
6. Insert the power cord into the back of the worksheet and into a grounded 120V AC outlet.

Note: Additional pads of Designer's Worksheet templates are available from your dealer or ETC.

- Set the three sets of DIP switches on the worksheet as indicated in the chart below.

Switch A

1	2	3	4	5	6	7	8
Off	Off	On	On	On	On	On	Off

Switch B

1	2	3	4	5	6	7	8
Off	On	Off	On	Off	Off	On	On

Switch C

1	2	3	4	5	6	7	8
On	On	Off	Off	Off	Off	On	Off

- Turn the worksheet power on by pressing the on/off switch. The LED labeled **Indicator** is lit when power is on. If LED blinks four times after you turn the power on, the interface cable is not connected correctly.
- Expression* displays the message **DWS ON** when the worksheet is properly installed and turned on.
- Press [Set Up], and select 6, **System Settings**.
- Select 17, **Designer's Worksheet Options**. *Expression* displays Designer's Worksheet Options Menu, illustrated on the next page.

GRAND MASTER 100%		DESIGNER'S WORKSHEET OPTIONS		MENU 1	
SELECT	FUNCTION				
* 1	12X12", LAYOUT WITH SUBMASTERS, CONSOLE CONTROLS LOCKED OUT				
2	12X12", LAYOUT WITH SUBMASTERS, CONSOLE CONTROLS ACTIVE				
3	12X12", LAYOUT WITHOUT SUBMASTERS, CONSOLE CONTROLS LOCKED OUT				
4	12X12", LAYOUT WITHOUT SUBMASTERS, CONSOLE CONTROLS ACTIVE				
5	17X12", CONSOLE CONTROLS LOCKED OUT				
6	17X12", CONSOLE CONTROLS ACTIVE				

SELECT FUNCTION NUMBER, THEN PRESS "ENTER"
(PRESS "CLEAR" TO RETURN TO SETUP MENU)

12. Select one of the displayed options. Options three through six are available only if your console has an expanded memory board. Expanded memory increases the number of available macros and regions from 125 to 640.

Installing Remote Focus Unit

The Remote Focus Unit (RFU) allows you to set channels levels, check dimmers or run cues from remote locations.

To install Remote Focus Unit, follow these steps:

1. Verify that RFU power switch is turned **Off**.
2. Insert the RFU cable into the connector on the back of the console labeled, **RFU/DWS**.
3. Turn RFU power switch to **On**. *Expression* displays the message, **RFU On**, when RFU is properly installed and turned on.

RFU connector and pinout

Console connector

XLR 6-pin female

Pinout

- 1 Data (+) (to RFU)
- 2 Data (-)
- 3 Data (+) (from RFU)
- 4 Data (-)
- 5 Common (AC ground)
- 6 +12 VDC (fused, 2 A)

Installing Redundant Tracking Backup

1. Configure both consoles for parallel printers:
 - a) Press [Set Up].
 - b) Select 6, **System settings** and press [Enter].
 - c) Select 10, **Serial/parallel printer**, and press [Enter].
 - d) Select 1, **Parallel**, and press [Enter].
2. Reset DIP switches on both consoles according to the chart below:

Both consoles	B4	On
Master console	B5	Off
Slave (backup) console	B5	On

Note: Expression reads DIP switch settings when you turn it on. You must turn power off and back on for console to recognize new settings.

3. Connect consoles with an RS-232 cable (Belden 9503 or equivalent) that is not longer than 50 feet. Use console connectors labeled **Serial**.

Cable pinout

DB9F _____	DB9F
2 _____	3
3 _____	2
5 _____	5

Pins 1, 6, 7, and 9 are not connected.

Pins 4 and 8 are tied together at each end but are not connected through cable.

Installing the alphanumeric keyboard

The alphanumeric keyboard is available only when an expanded memory card is installed. You can use the keyboard to assign alphanumeric names to cues, submasters, groups, and shows.

You can use a standard PC XT/AT compatible, manually switchable, alphanumeric keyboard with the expanded memory option. The keyboard can be used only in its XT-compatible mode. ETC recommends the Datacomp Electronics model DFK121A08 and Unitek K-155 keyboards. Although you may be able to use keyboards from other manufacturers, ETC does not guarantee the results.

Follow these steps to install the alphanumeric keyboard:

1. Be sure the selector switch is set to the *XT* position.
2. Insert the keyboard cable into the connector labeled **Keyboard** on the *Expression* back panel.

Note: Console must be off when keyboard is plugged in.

Keyboard connector and pinout

Console connector

DIN 5-pin female

Keyboard pinout

- 1 Clock
- 2 Data
- 3 Reset
- 4 Ground
- 5 +5V DC

Installing Infrared Remote Focus Unit

The Infrared Remote Focus Unit (IRFU) allows you to set channel levels, check dimmers, or run cues from remote locations in your studio or theatre. The IRFU consists of two components; a receiver and a transmitter. The receiver is connected to the console with a standard multi-conductor cable. The transmitter is a hand-held, wireless unit that sends infrared control signals to the receiving unit. To enable the IRFU in *Expression*, ETC must modify the console at the factory.

To install the infrared remote control unit, follow these steps:

1. Verify that the receiver unit is properly connected to the console and that battery in transmitter is good. (See infrared remote documentation for correct connection procedure.)
2. Press [Set Up].
3. Select 6, **System settings**, and press [Enter].
4. Select 15, **Enable/disable infrared control**, and press [Enter].
5. Enter **0** to enable infrared controller, and press [Enter].
6. Press any key on the transmitter unit to turn power on. (Transmitter power automatically shuts off three minutes after last key press.)

Infrared Remote Focus Unit pinout

Console connector

DIN 5-pin female

Pinout

- 1 Ground
- 2 PPM data
- 3 +12V
- 4 WSI data
- 5 Charge current

Installing Remote Submasters and Macros

Remote Submasters and Remote Macros are custom-installed ETC products. To enable Remote Submasters and Macros, ETC must modify the console at the factory.

Follow these steps to begin remote operation:

1. Verify that all control cables are properly connected. Check connections at rear of main control console, wall plug connections and connections at all remote panels.
2. Press [Set Up].
3. Select 6, **System settings**, and press [Enter].
4. Select 13, **Enable/disable remote submasters**, and press [Enter].
5. Enter 0 to enable or 1 to disable, and press [Enter].

chapter 3

entering softpatch and system settings

Before you begin creating cues for a show you should first create your softpatch. The softpatch assigns individual dimmers to control channel numbers. You can use a default one-to-one softpatch setup, or you can assign groups of dimmers to channels. The softpatch screen lets you proportionally patch dimmers to channels.

System settings also allow you to indicate default up and down fade times, default fader clear times, enable and disable bump switches, and the level that the [Full] key enters for selected channels.

This chapter includes the following system setting instructions:

- Entering softpatch
- Setting default full level
- Setting default up and down fade times
- Setting default fader clear times
- Enabling and disabling bump switches

Entering softpatch

Expression accommodates up to 512 dimmers (or 1,024 if you have the optional second DMX512 connector) in 250 channels. Softpatch gives you complete flexibility in assigning dimmers to control channels in any order.

Softpatch also allows you to proportionately assign levels to individual dimmers to balance a wash or ensure that a specific lamp cannot be brought above a specific level. For instructions see page 3 - 8.

In addition, you can select from 10 dimmer profiles for each individual dimmer. Dimmer profiles allow you to select a nonlinear output curve for dimmers. For instructions on selecting dimmer profiles see page 3 - 9.

You will find instructions on the following pages for one-to-one softpatch, customized softpatch and additional softpatch features.

If you are patching dimmers in a Strand CD80 dimmer rack, see page 3 - 12 for special instructions.

Entering one-to-one softpatch

If you have the same number of dimmers and channels, you may want to use a one-to-one softpatch. A one-to-one patch assigns dimmer one to channel one, dimmer two to channel two, and so on. If you have more dimmers than channels, the default setting assigns the first extra dimmer to channel one, the second extra dimmer to channel two, and so on.

To use *Expression's* default softpatch setting follow these steps:

1. Press [Set Up].
2. Select 6, **System Settings**, and press [Enter].
3. Select 4, **Customize Channels**, and press [Enter].
4. Enter the total number of required channels, up to 250, and press [Enter].
5. Select 7, **Customize Dimmers**, and press [Enter].
6. Enter the total number of required dimmers, up to 512*, and press [Enter].
7. Select 8, **Default softpatch**, and press [Enter].
8. Press [Rec] to assign the default softpatch settings. Or, press [Clear] to cancel the operation.
9. See instructions in this chapter titled *Proportional patching* for instructions on inhibiting individual dimmer levels within a channel.

Note: For instructions on performing a dimmer check from the patch screen (without returning to Stage mode), see the section titled Capturing channels in softpatch later in this chapter.

*Or 1,024 dimmers if you have the optional second DMX512 connector.

Creating custom softpatch

The following sections include information about creating a custom softpatch.

- Using channel zero
- Entering numbers of channels and dimmers
- Patching dimmers to channels

Hint: If you use the same softpatch for several shows, create the softpatch, and record it on a disk before you record any cues. Label the disk Standard patch. When you start your next show, read the Standard patch show into the console, then begin writing cues to avoid reentering the patch.

Using channel zero

Channel zero works as a holding area for unused dimmers. Channels assigned to channel zero are listed at the end of channel list under “_”.

These dimmers are not assigned to any channel, but remain on the softpatch screen.

To assign dimmers to channel zero, enter dimmer numbers, press [Chan], then [0] [Enter].

Hint: You may choose to begin softpatching by assigning all dimmers to channel zero. Then select dimmers or dimmer groups from channel zero and reassign them to other channels. This lets you start with a clean softpatch screen. You can then display all unused dimmers by selecting channel 0.

Entering numbers of channels and dimmers

You may want to enter the number of available channels and dimmers before you begin custom patching. To do so, follow these steps:

1. Press [Set Up].
2. Select 6, **System Settings**, and press [Enter].
3. Select 4, **Customize Channels**, and press [Enter].
4. Enter the total number of required channels, up to 250, and press [Enter].
5. Select 7, **Customize Dimmers**, and press [Enter].
6. Enter the total number of required dimmers, up to 512*, and press [Enter].

*Or 1,024 dimmers if you have the optional second DMX512 connector.

Patching dimmers to channels

Each dimmer can only be patched to one channel at a time. Follow the steps below to create a custom softpatch.

1. Press [Patch]. *Expression* displays the following screen.

GRAND MASTER 100%					SOFTPATCH	DIMMER
CHN	DIMMER	LEVEL	PROFILE			
01	1	251	501	751	1001	
02	2	252	502	752	1002	
03	3	253	503	753	1003	
04	4	254	504	754	1004	
05	5	255	505	755	1005	
06	6	256	506	756	1006	
07	7	257	507	757	1007	
08	8	258	508	758	1008	

PROFILES:
 0-LINEAR 1-IES SQUARE 2-SLOW BOTTOM 3-FAST BOTTOM 4-SLOW TOP
 5-FAST TOP 6-FULL AT 1% 7-PREHEAT 5% 8-PREHEAT 10% 9-HOT PATCH

SELECT DIMMER NUMBERS, THEN PRESS "ENTER" TO ASSIGN TO A CHANNEL
 OR PRESS "AT" TO ASSIGN A LEVEL, OR PRESS "TYPE" TO ASSIGN A PROFILE

2. Select dimmers to assign to a single channel.

To select a single dimmer:

- a) Enter the dimmer number.
- b) Press [Enter].

To select a range of consecutive dimmers:

- a) Enter beginning dimmer number.
- b) Press [Thru].
- c) Enter the ending dimmer number.
- d) Press [Enter].

To select a discontinuous set of dimmers:

- a) Enter dimmer number.
- b) Press [And].
- c) Enter additional dimmer numbers, pressing [And] between each.
- d) Press [Enter] after you have selected all desired channels.

Shortcut: Combine [And] and [Thru] commands to select any combination of dimmers. For example, press [1] [Thru] [5] [And] [1][0] [Thru] [2][0] to select one through five and 10 through 20.

3. Enter the channel number to which you want to assign selected dimmers; then press [Enter].
4. To patch remaining dimmers, repeat steps two and three.
5. See instructions in this chapter titled *Proportional patching* for instructions on inhibiting individual dimmers.

Additional patching features

The following patching features are described below:

- Proportional patching
- Dimmer profiles
- Capturing channels in softpatch
- Unpatching individual dimmers
- Softpatching to Strand CD80 dimmer rack

Proportional patching

Expression lets you proportionally inhibit individual dimmer levels from the softpatch screen. You may want to inhibit an individual dimmer to balance the wash in a channel or to limit a particular lamp. Dimmers default to a full level setting unless you inhibit them.

To inhibit individual dimmers levels, follow these steps:

1. If Softpatch screen is not displayed, press [Patch].
2. Press [Dim] to indicate that next number entered will be a dimmer.
3. Enter desired dimmer number, or select a group of dimmers by using [And] and [Thru] in conjunction with dimmer numbers.
4. Press [At], and enter desired intensity level for dimmer.

As long as dimmers are selected (highlighted on monochrome monitor or displayed in yellow on a color monitor) you can adjust their levels with [+] and [-].

Dimmer intensity levels set in softpatch function at full level on all other screens. For example, if you enter a level of 60 for a dimmer on the softpatch screen, when you set that channel to full in a cue or submaster, the dimmer will output at 60 percent.

Dimmer profiles

Dimmer profiles allow you to select a specific output curve for a dimmer over the range of a fade. This can compensate for nonlinear light outputs from certain types of fixtures or incorporate a preferred response in a fade. If you do not select a dimmer profile, the console defaults to a linear output.

To select a dimmer profile for a specific dimmer, follow these steps:

1. Press [Patch].
2. Press [Dim], and enter dimmer number or a range of dimmer numbers using [And] and [Thru].
3. Press [Type].
4. Enter profile number. Profile numbers are listed on menu at the bottom of the softpatch screen. Each is also described below. For illustrations of dimmer profiles, see page 8 - 24.

- 0 - Linear
- 1 - IES square
- 2 - Slow bottom
- 3 - Fast bottom
- 4 - Slow top
- 5 - Fast top
- 6 - Full at 1% *
- 7 - Preheat 5%^{†‡}
- 8 - Preheat 10%^{†‡}
- 9 - Hot patch^{†‡}

* Dimmer intensity jumps from 0% to 100% at 1% output.

† Dimmer at 5% or 10% whenever console power is on. Dimmer intensity increases when output exceeds 5% or 10%.

‡ Dimmer at full whenever console power is on.

¶ Affected by [Black Out] but not by Grand Master.

Resetting factory dimmer profiles and all dimmers to default setting

The Default Dimmer Profiles option on the System Settings Menu allows you to reset all dimmers to the default (linear) profile and the dimmer profiles to the original factory settings.

1. Press [Set Up].
2. Select 6, **System Settings**, and press [Enter].
3. Select 9, **Default dimmer profiles**, and press [Enter].

Capturing channels in softpatch

Expression lets you select and capture channels without returning to Stage mode so you can bring channels up on stage to view the proportional settings of dimmers assigned to a channel while you set them. To select channels from the softpatch screen, follow these steps:

1. Press [Patch].
2. Press [Chan].
3. Enter channel number, or select a range of channels.
4. Press [Full] to set channel level at 100 percent, or press [At] and enter a level setting.
5. Press [Rel] to release channel(s).

Unpatching individual dimmers

[Dim] lets you select a single dimmer and bring it up independent of other dimmers softpatched to the same channel. This is called unpatching a dimmer. If a channel has more than one dimmer softpatched to it, you may want to unpatch a single dimmer to check individual fixtures, to turn on a work light, or to focus a single dimmer from the channel. You must be in Stage mode to unpatch a dimmer.

To unpatch a dimmer, follow these steps:

1. Determine which dimmer you want to unpatch. You may want to display the softpatch screen to display the current dimmer to channel patching. To display the softpatch screen, press [Patch].
2. Press [Stage].
3. Press [Dim].
4. Enter the dimmer number you want to unpatch. Unpatching does not affect the level that other dimmers in the channel are set at. If you want all other dimmers in the channel off, set the channel at zero.
5. To set the unpatched dimmer at full intensity, press [Enter]. Or, to set the unpatched dimmer at less than full, press [At], and enter a two-digit level; then press [Enter].
6. Press [Dim] [Clear] to restore dimmer to patch. You can perform most other console tasks with dimmer unpatched, then restore the patch at any time. Entering the softpatch screen also restores patch.

Note: When you unpatch a dimmer and set it to full intensity, the output is 100 percent of the potential output, not 100 percent of the level at which it is softpatched.

Hint: To perform a dimmer check from Stage, press [Dim] [1] [Enter]. Then use [+] and [-] to step through remaining dimmers for dimmer check.

Softpatching to a Strand CD80 dimmer rack

Strand CD80 dimmer racks have 48 dimmer slots. Each dimmer slot holds either two 2.4 kw dimmers or one 6 kw or 12 kw dimmer. The console requires that you include all 96 possible dimmer numbers per rack in the softpatch.

Refer to the charts below to determine dimmer numbers for each slot on each rack. When patching 6 kw or 12 kw dimmers, enter the slot's odd dimmer number under the desired channel number. Enter the slot's even dimmer number under channel 0.

For example, to patch a 6 kw dimmer into the last dimmer slot on the first rack, enter dimmer 95 in the desired channel number and dimmer 96 in channel 0.

1	3	5	7	9	11
2	4	6	8	10	12
13	15	17	19	21	23
14	16	18	20	22	24
25	27	29	31	33	35
26	28	30	32	34	36
37	39	41	43	45	47
38	40	42	44	46	48
49	51	53	55	57	59
50	52	54	56	58	60
61	63	65	67	69	71
62	64	66	68	70	72
73	75	77	79	81	83
74	76	78	80	82	84
85	87	89	91	93	95
86	88	90	92	94	96

97	99	101	103	105	107
98	100	102	104	106	108
109	111	113	115	117	119
110	112	114	116	118	120
121	123	125	127	129	131
122	124	126	128	130	132
133	135	137	139	141	143
134	136	138	140	142	144
145	147	149	151	153	155
146	148	150	152	154	156
157	159	161	163	165	167
158	160	162	164	166	168
169	171	173	175	177	179
170	172	174	176	178	180
181	183	185	187	189	191
182	184	186	188	190	192

Entering system settings

These system settings are discussed on the following pages:

- Default full level
- Default up and down fade times
- Default fader clear time
- Enable/disable bumpswitches

To display the System Settings Menu, follow these steps:

1. Press [Set Up].
2. Select 6, **System Settings**, and press [Enter]. The system setting menu is illustrated below.

GRAND MASTER 100%		SYSTEM SETTINGS	MENU
SELECT	FUNCTION		
1	DEFAULT FULL LEVEL		
2	DEFAULT UP/DOWN TIMES		
3	DEFAULT FADER CLEAR TIME		
4	CUSTOMIZE CHANNELS		
5	SELECT MIDI CHANNEL		
6	LEVEL/PROPORTIONAL RATE OVERRIDE		
7	CUSTOMIZE DIMMERS		
8	DEFAULT SOFTPATCH		
9	DEFAULT DIMMER PROFILES		
10	SERIAL/PARALLEL PRINTER		
11	COLOR/MONOCHROME MONITOR		
12	FAST/FULL BOOT TEST		
13	ENABLE/DISABLE REMOTE SUBMASTERS		
14	ENABLE/DISABLE BUMP SWITCHES		
15	ENABLE/DISABLE INFRARED CONTROL		
16	DIAGNOSTIC SYSTEM CLEAR		
17	DESIGNER'S WORKSHEET OPTIONS		
18	ENABLE/DISABLE FLEXICHANNELS		

SELECT FUNCTION NUMBER, THEN PRESS "ENTER"
(PRESS "CLEAR" TO RETURN TO SETUP MENU)

Setting default full level

The default full setting is the level *Expression* enters for selected channels when you press [Full]. [Full] is set originally at 100 percent, and is reset to 100 percent after a diagnostic system clear.

When you set the default full level below 100 percent, you can still set channels above the [Full] level setting by using [At], [+], [-], or the fader wheel. To set [Full] at a level other than 100 percent, follow these steps:

1. Press [Set Up].
2. Select 6, **System Settings**, and press [Enter].
3. Select 1, **Default Full Level**, and press [Enter].
4. Either enter a two-digit intensity level, or press [Full] to set level at 100 percent.

Note: When you set dimmer levels on the softpatch screen, [Full] enters 100 percent regardless of the default full level setting.

Setting default up and down fade times

Expression automatically enters default up and down fade times unless you specifically change them. A diagnostic system clear resets the defaults to five seconds. To customize default fade times, follow these steps:

1. Press [Set Up].
2. Select 6, **System Settings**, and press [Enter].
3. Select 2, **Default Up/Down Times**, and press [Enter].
4. Enter upfade time in minutes and seconds or as a fraction of a second in decimal format, then press [enter]. Fade times can be from .1 second to 99:59 minutes.
5. Enter downfade time in minutes and seconds or as a fraction of a second in decimal format, then press [Enter]. Fade times can be any length of time from .1 second to 99:59 minutes.

Setting default fader clear times

The default fader clear time is the length of time required for a fader pair [Clear] to fade out channels from the faders. A diagnostic system clear resets [Clear] fade time to zero; channels black out immediately when clear time is zero.

To change the fader clear time, follow these steps:

1. Press [Set Up].
2. Select 6, **System Settings**, and press [Enter].
3. Select 3, **Default Fader Clear Time**, and press [Enter].
4. Enter fader clear time in minutes and seconds or as a fraction of a second in decimal format. Fade times can be any length of time from .1 second to 99:59 minutes.
5. Press [Enter].

Enable/disable bump switches

Bump switches are momentary switches that flash submasters to their full recorded levels or initiate a timed submaster. You may disable bump switches to eliminate the possibility of accidentally bringing up unwanted channels.

When bump switches are disabled, submaster slide pots function normally. To enable or disable bump switches, follow these steps:

1. Press [Set Up].
2. Select 6, **System Settings**, and press [Enter].
3. Select 14, **Enable/disable bump switches**, and press [Enter].
4. Select 0 to enable or 1 to disable bump switches.
5. Press [Enter].

Enable/disable Flexichannel

Flexichannel is an optional display mode that displays only selected channels and channels that are recorded in a cue, submaster, group, or effect.

To enable or disable Flexichannel, follow these steps:

1. Press [Set Up].
2. Select 6, **System Settings**, and press [Enter].
3. Select 18, **Enable/disable Flexichannel**, and press [Enter].
4. Select 0 to enable or 1 to disable bump switches.
5. Press [Enter].

chapter 4

learning the basics

This chapter includes lessons on working with *Expression's* basic features: cues and submasters. When you complete the lessons, you will have a short sample show to run. Each lesson is described briefly below.

- Lesson 1 describes display and channel modes and record functions.
- Lesson 2 includes instructions for creating several cues using several different methods.
- Lesson 3 includes instructions for playing back cues and submasters.
- Lesson 4 includes instructions for creating submasters using several different methods.
- Lesson 5 includes instructions for saving your work on disk.

If these lessons seem too elementary for you, but you want some guidance on advanced features, read *Chapter 5, Learning advanced techniques*. For an alphabetical listing and explanation of all features, keystrokes and menu options, see *Chapter 8, Reference*.

Lesson 1

Display, channel and record modes

This lesson describes display and channel modes and record functions available in *Expression*. Display modes show channel and level settings for cues, submasters, groups and fader pairs. Channel modes indicate how channels respond when they are in different situations.

Expression's record functions create cues differently. See *Record functions* on page 4 - 8 for more information.

Display modes

You can work in any of four different modes to create and modify cues, groups and submasters: Stage, Blind, Fader, or Track Sheet. The first three modes have very similar screens; the Stage screen is illustrated and described on the next page. The Track Sheet screen is illustrated and described on page 5 - 17.

Stage

Stage mode controls live channels. This mode allows you to adjust lighting levels and save a look as a cue, group or submaster when you are satisfied with the look on stage.

Blind

Blind mode allows you to work on cues, groups or submasters without affecting the stage lights. Blind mode is useful when you know ahead of time what channels and levels you want for most of your cues and submasters. Blind also lets you jump ahead of the stage action and make changes to recorded cues, groups or submasters without affecting live stage lighting.

Fader

Fader mode lets you make live adjustments to channels that are in one fader pair while another cue is currently running in the other. For example, if you have a cyclorama cue in one fader and a stage cue in the other, Fader mode lets you modify the stage cue live and record changes without capturing the cyclorama cue. Fader mode is not included in this tutorial, but it is described in *Chapter 8, Reference*.

Track Sheet

Track Sheet displays a specific channel's level settings in all recorded cues. This display is useful when you need to add or modify a single channel in several cues. Track is a blind mode; it does not give you live control of channels. Track Sheet mode is included in *Chapter 5, Learning advanced techniques*. You can modify existing cues, but you cannot create cues in Track Sheet.

Flexichannel

Flexichannel is a feature of *Expression's* expanded memory option. It is available only when expanded memory is installed.

When the Flexichannel mode is enabled, *Expression's* monitor displays only selected channels, and channels that are part of a recorded cue, submaster, group, or effect; other channels do not appear on the display screen. This simplifies console operation by eliminating unused channels from the display screen. Once you have selected a channel, the only way to remove it from the display is to repeat the procedure for enabling Flexichannel. See *Chapter 8, Reference*, page 8 - 35 for information on enabling and using Flexichannel.

Stage, Blind and Fader screens

Stage, Blind and Fader screens look very similar. The Stage mode screen is illustrated below to familiarize you with the screen format.

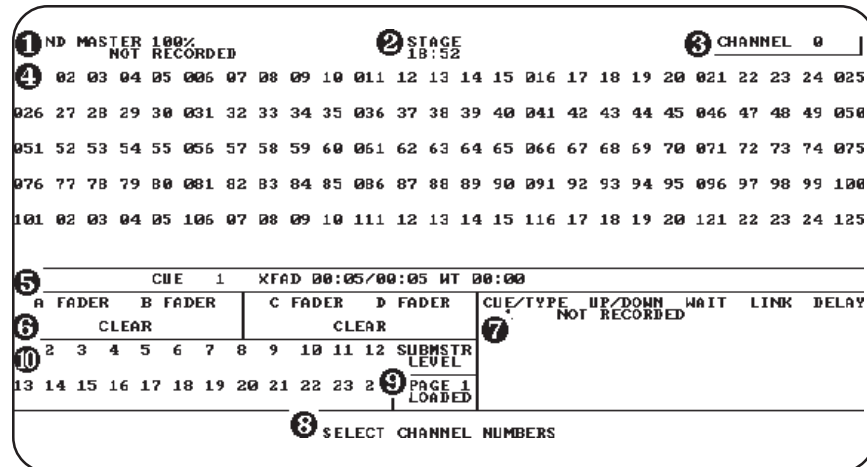

1 Grand master setting

The grand master setting displays the master intensity level. With it you can proportionally inhibit the level of all channels. The grand master overrides all other settings.

2 Mode label

This field displays the current mode, either Stage, Blind or Fader.

3 Keypad prompt window

This window indicates how the console will interpret the next number you enter from the keypad. For example, if you press [Chan], the keypad prompt window displays the message **Channel**, indicating that the console will read the next number you enter as a channel number.

4 Channel display

The channel display lists available channels and their current levels. If you have a color monitor, *Expression* color codes level displays to

provide additional information about channels. For example, in Blind mode tracked channels are green. See the section *Channel modes* on page 4 - 6 for further description.

Note: In Flexichannel display mode, only selected channels and channels that are part of a recorded cue, submaster, group, or effect are displayed; other channels do not appear on the display screen. Channels are displayed in vertical columns rather than in horizontal rows. The Flexichannel display is a feature of Expression's expanded memory option. See Chapter 8, Reference, Flexichannel for more information.

⑤ **Cue/submaster description line**

The cue/submaster description line displays information about the currently selected cue, group or submaster. The summary includes cue, group or submaster number, up and down fade times, wait and delay times, fade or submaster type, and link information, if applicable.

⑥ **Fader windows**

Fader windows display fade time information for cues loaded in fader pairs. The window displays the cue number, a running clock of the fade, and the percentage of the fade time that has run.

⑦ **Cue sheet**

The cue sheet lists up to nine stored cues. Each cue listing includes fade, wait and delay times, and cue name and link information.

⑧ **Operator prompt line**

The operator prompt line displays messages to guide you through *Expression* operations. For example, when you press [Chan], this line displays the message, **Select channel numbers**. If you are having problems, look here for information or help.

⑨ **Page display**

The page display indicates which submaster page is currently loaded. If any submasters from the previously loaded page are still active, the message **Page 2 loading** is displayed. The message changes to **Page 2 loaded** when all submasters are loaded from the new page.

⑩ **Submaster window**

The submaster window displays the current level settings for submasters. On a color monitor, pile-on submasters are displayed in green, and inhibitive submasters are displayed in red.

Channel modes

Channels may be in any of the following modes. Each mode responds differently to your commands.

Captured channels

Captured channels are channels that you have selected and are live on stage. They remain live until you press [Rel] to release them. **Captured channels override all other channel settings.** For example, if a channel is in a fader at 100 percent and you capture it and set it to 50 percent, *Expression* reads the 50 percent setting from the captured channel.

You can capture channels while in either Stage or Fader mode, but not Blind or Track Sheet modes since they are not live. *Expression* displays captured channels in red and yellow on a color monitor. Red channels are captured; yellow channels are captured *and* selected (see below).

Selected channels

Selected channels are channels that you have immediate keyboard control over. You can modify selected channels with [Full], [At], [+], [-], or the fader wheel. Selected channels are highlighted on a monochrome monitor and are displayed in yellow on a color monitor. You can select channels in all display modes.

Selected, captured channels are live channels that are under immediate keyboard control. Channels can be *selected and captured* only in live modes. You can select channels in Blind, but they won't be captured since Blind mode is not live.

Recorded channels

Recorded channels are channel levels that have been recorded in a cue, group or submaster. In live modes (Stage and Fader), recorded levels appear on the screen only when they are in a fader pair or in an active submaster. On a color monitor in Stage mode, recorded levels are displayed in blue. Recorded channels may be either moving or tracked in Blind mode (see below).

Moving channels

Moving channels are channel levels that change from one cue to the next. In Blind mode on a color monitor, moving channels are displayed in blue. On a monochrome monitor, they are not displayed differently than tracked channels.

Tracked channels

A tracked channel is a channel whose level is unchanged from the preceding cue. On a color monitor, tracked channels are displayed in green in Blind mode and on Track Sheet. Tracked channels are not distinguished in Stage mode.

Record functions

Expression has two record functions Record and Track. Record saves all channels as they appear on the screen (what you see is what you get) in the cue, group or submaster you specify. When you use Record to record a cue, levels are recorded in only the cue you specify.

Track is a record function that works only for cues. It allows you to build a new cue from the previous cue's channel settings. Tracked channels are channels whose levels do not change from one cue to the next. A *track* often runs through several cues for the length of a scene or an act.

Track also allows you to add tracked channels through existing cues. For example, if you have created all cues for a scene, and then decide to add a new channel or group of channels to all cues, Track lets you do so with one short record command. To do the same thing with Record would require you to add the channels to each cue individually.

We use the standard Record function for all cues in this chapter. Instructions for using the Track function are included in *Chapter 5, Learning advanced techniques*.

Lesson 2

Working with cues

Now that you have an orientation to the channel display screens, you're ready to create cues. If you are not sitting at the console but want to refer to the keyboard, see *Appendix D* for an illustration.

When working with *Expression*, a *cue* is a look you have created and recorded, and can replay in a timed fader pair. After you select channels and set their intensity levels, you can store the look as a cue. You can save up to 400 cues per show in *Expression*. Each disk can hold two shows. If your performance runs over 400 cues, you can read a second show from disk during a break, or between cues. See *Lesson 5* for more information about recording shows on disk.

This lesson includes instructions and examples for creating cues using several different methods. When you have completed the lesson, you will have five cues recorded. You will also know how to modify and delete cues.

Naming cues with expanded memory

If you have installed the expanded memory option, you can use a standard PC XT compatible, alphanumeric keyboard to assign alphanumeric names to cues, groups and submasters. The alphanumeric keyboard is an optional feature available with *Expression's* expanded memory option and is available only when expanded memory is installed. See page 7 - 3 for more information on using the alphanumeric keyboard to name cues.

Creating cues

Five cues are included in the following instructions. The first few are simple; the rest use more complicated features. This lesson includes the following sections:

- Cue 1, Creating a cue in Stage
- Cue 2, Creating a cue in Blind
- Cue 3, Modifying up and down fade times
- Cue 4, Linking cues
- Cue 5, Creating a cue using Solo
- Deleting cues
- Viewing cues

There are several methods you can use to create any one look with *Expression*. Deciding how to create a look depends on your situation and what information is already stored in the console.

If you have several cues already stored, you may want to use the look from one cue and add to it to create another. In another circumstance, you may want to enter all channel levels from scratch.

If you are in the middle of a tech rehearsal you will probably want to use Stage mode so you can see your adjustments live. If you have a good idea of how you want cues to look, you may want to record the show in Blind ahead of time.

The following instructions include general instructions with numbered steps. Then there are specific keystroke sequences to create sample cues.

There are several ways you can go about creating any one look. The following instructions give examples of how you *could* generate each cue. Experiment and add as much as you want to each.

We assume that when you start this tutorial there are no cues stored in the console. To erase the current show from the console, follow this key sequence: [Set Up] [6] [Enter] [1][6] [Enter] [Enter]. *Before you clear the console, make sure that the show currently in the console memory is saved on disk. When you clear the console, all show information is erased.*

Cue 1: Creating a cue in Stage

Follow these steps to create a cue in Stage mode:

1. Press [Stage]. *Expression* displays the Stage mode screen. Once you are in Stage, you have live control of channels. *Expression* automatically prompts you to enter a channel number.
2. Enter channel number(s) with numeric keypad.
3. Set intensity level by pressing [At] and entering a two-digit level, moving the fader wheel, or pressing [+] and [-].
4. Press [Rec] to indicate that you want to record the cue.
5. Enter cue number with numeric keypad.
6. Press [Enter] to record cue. *Expression* returns to the **Enter channel** prompt.
7. Press [Rel] to release captured channels.

Cue 1 keystrokes:

Key	Action
[Stage]	Displays Stage mode.
[1]	Selects channel 1.
[At]	Indicates next number entered will be an intensity level.
[7][5]	Enters intensity level of 75 percent.
[Rec]	Indicates that you want to record cue.
[1]	Enters cue number.
[Enter]	Records cue.
[Rel]	Releases captured channels.

Cue 2: Creating a cue in Blind

Follow these steps to create a cue in Blind mode, for a range of channels, using [Full]. *Expression* automatically enters 00 for channels you used in cue 1 to indicate that they will downfade in cue 2.

1. Press [Blind]. *Expression* displays Blind mode screen. You do not have live control of channels in Blind. *Expression* automatically prompts you to enter cue number.
2. Enter cue number you want to record or display.
3. Press [Chan] to indicate that the next number entered will be a channel number.
4. Enter channel number to mark start of a range of channels.
5. Press [Thru] to indicate you are entering a range of channels.
6. Enter channel number to mark end of range. Selected channels are highlighted or displayed in yellow.
7. Press [Full] to set channels at full intensity level.
8. Press [Rec] to indicate that you want to record the cue.
9. Press [Enter].

Note: When using [Full], you do not have to press [At] first.

Cue 2 keystrokes:

Key	Action
[Blind]	Displays Blind mode screen.
[2]	Selects cue 2.
[Chan]	Indicates that the next number entered will be a channel.
[1]	Selects channel 1.
[Thru]	Indicates you are going to enter a range.

Note: If you are entering a range of channels in Flexichannel mode, you must press [Thru] [Thru] to indicate a range.

[1][5]	Marks end of range. Channels 1 through 15 are selected.
[Full]	Enters full intensity level for selected channels.
[Rec]	Indicates you want to record the cue.
[Enter]	Records cue.

Cue 3: Modifying up and down fade times

You may also want to modify cue up and down fade times. When you create a cue, *Expression* assumes you want to use the default fade times. However, you can easily change fade times using [Time]. See page 3 - 15 for instructions on changing default fade times.

1. Press [Blind] if the Blind mode screen is not already displayed.
2. Add channels using numeric keypad and [And] or [Thru]; then enter intensity levels.
3. Press [Rec] to indicate that you want to record the cue.
4. Enter cue number, and press [Enter].
5. Press [Time].
6. Enter upfade time between .1 and 99:59. You can enter time either in minutes and seconds or a fraction of a second in decimal format. For example, all of the following are acceptable: .2, 00:12, 5.5, 5:30.
7. Press [Enter].
8. Enter downfade time, if different from upfade time. Enter a time between .1 and 99:59. If you do not enter a time, *Expression* assumes you want the same downfade time as upfade time.
9. Press [Enter].
10. Enter wait time. Wait time is the length of time after *beginning* the upfade before the downfade starts. If you do not enter a wait time, *Expression* assumes you want a wait time of zero.

Note: If you modify fade times after you record the cue, you do not have to rerecord the cue. Fade and wait times are automatically added to cue information.

11. Press [Enter].

Cue 3 keystrokes:

If you did not press [Rel] after you saved the last cue, channels 1 through 15 should still be selected on the Blind mode screen.

Key	Action
[Chan]	Indicates next number entered will be a channel.
[2][6]	Marks beginning of range.
[Thru]	Indicates that you are entering a range.

Note: If you are entering a range of channels in Flexichannel mode, you must press [Thru] [Thru] to indicate a range.

[5][0]	Marks end of range.
[Full]	Enters full intensity for selected channels.
[Rec]	Indicates you want to record cue.
[3]	Enters cue number.
[Enter]	Records cue.
[Time]	Indicates that you want to change fade times.
[1][0]	Enters ten second upfade time.
[Enter]	Enters upfade time and prompts you for downfade time.
[Enter]	Enters same fade time as for upfade.
[.5]	Enters half-second wait time.
[Enter]	Records time settings.

Cue 4: Linking cues

Expression lets you link cues to create a sequence that runs automatically. You can link a string of cues, or you can create a loop to produce a chase. You can also link cues to macros. For more information on linking cues to macros, see page 8 - 46 in *Chapter 8, Reference*.

1. Create and record a cue using techniques described for cues 1 through 3.
2. Press [Link].
3. Enter cue number to which you want to link current cue. You can enter either a cue number that exists already or one you are going to create. Press [Enter].

On the cue description line, the number of the linked cue and **LK** appears. This information is also added to the cue sheet.

4. Enter delay time in minutes and seconds or as a fraction of a second in decimal form. Delay times may be between .1 second and 99:59.

The delay time is the length of time between the start of the first cue and the start of the cue it is linked to. For example, if the delay time for the link is 10 seconds, the second cue upfade starts 10 seconds after the first cue's upfade begins.

Expression enters a default delay time that equals the total running time of the first cue. That way, the cues run back to back. The total running time of a cue is the longer of either the upfade time or sum of the wait and downfade times.

To change the delay time for a cue that is already linked, press [Link] twice, enter delay time, and press [Enter].

Note: If you are entering link information for existing cues, you do not have to rerecord the cue.

Cue 4 keystrokes:

Key	Action
[Blind]	Displays Blind mode screen.
[Chan]	Indicates that you are going to enter channel numbers.
[5][1]	Selects channel 51.
[Thru]	Indicates that you want to enter a range of channels.
<i>Note: If you are entering a range of channels in Flexichannel mode, you must press [Thru] [Thru] to indicate a range.</i>	
[7][5]	Marks end of range of channels at 75.
[Full]	Sets captured channels at full intensity.
[Rec]	Indicates you want to record the cue.
[4]	Enters cue number.
[Enter]	Records cue.
[Link]	Indicates that you are going to link another cue to cue 4.
[5]	Selects cue 5 to link cue 4. Note that in this example we have not created the link-to cue yet.
[Enter]	Enters cue link information.
[1][0]	Sets delay time to 10 seconds.
[Enter]	Enters delay time.

Cue 5: Creating a cue using Solo

Often you will create cues by adding to, subtracting from and modifying previously recorded cues. [Solo] lets you select a subset of displayed channels and delete all others.

1. Press [Chan] to indicate that the next number entered will be a channel number.
2. Enter channel number to mark the beginning of the subset to select.
3. Press [And] or [Thru] to indicate you are selecting a range of channels.
4. Enter another channel number with numeric keypad to mark the end of the range.
5. Press [Solo]. *Expression* deletes all unselected channels.
6. Move the fader wheel, press [At], [+] and [-], or use [At] and numeric keypad to set desired level.
7. Press [Rec] to indicate that you want to record the cue.
8. Enter cue number with numeric keypad.
9. Press [Enter] to record cue.

Cue 5 keystrokes:

Assuming you are still in Blind and have cue 4 displayed, follow these steps to create a cue using [Solo]:

Key	Action
[Chan]	Indicates that the next number entered will be a channel number.
[6][0]	Marks the beginning of the subset.
<i>Note: If you are entering a range of channels in Flexichannel mode, you must press [Thru] [Thru] to indicate a range.</i>	
[Thru]	Indicates you are selecting a range of consecutive channels.
[6][5]	Marks the end of the range.
[Solo]	Deletes all unselected channels (all channels except 60 through 65).
Fader wheel or [At], [+] and [-], [At] and numeric keypad	Sets desired level.
[Rec]	Indicates that you want to record the cue.
[5]	Enters cue number.
[Enter]	Records cue.

Inserting cues

You may want to insert a cue between recorded cues. For example, you may want to modify cue 1 slightly and insert it between cues 1 and 2. You can number cues with a one-digit decimal. Therefore, you can insert up to nine cues between one and two (1.1, 1.2, etc.). To modify and insert a cue, follow these steps:

1. Press [Blind]. *Expression* automatically prompts you for a cue number.
2. Enter cue number you want to modify.
3. Make modifications.
4. Press [Rec].
5. Enter cue number with a decimal to insert it between cues. If you do not enter a new cue number, you will overwrite the existing cue.
6. Press [Enter].

Insert cue keystrokes:

Key	Action
[Blind]	Displays Blind mode screen.
[1]	Displays cue 1.
[Chan] [1][0] [Thru] [1][5], fader wheel	Modifies cue.
[Rec]	Indicates you want to record cue.
[1] [.] [1]	Enters cue number 1.1.
[Enter]	Records and inserts cue 1.1 between cues 1 and 2.

Deleting cues

Follow these steps to delete a cue from a show.

1. Press [Blind]. You cannot delete cues from live modes.
2. Enter cue number you want to delete.
3. Press [Clear].
4. To delete just the current cue, press [Rec].

To delete the current cue and any channels that track from that cue, press [Track].

5. Press [Enter].

For more information on tracking, see *Chapter 5, Learning advanced techniques*.

Deleting cue keystrokes:

Key	Action
[Blind]	Displays Blind mode.
[Cue]	Indicates next number entered will be a cue.
[1]	Displays cue 1 on Blind mode screen.
[Clear]	Indicates you want to delete cue.
[Rec]	Indicates that you want to delete just this cue, not the tracks.
[Enter]	Deletes cue 1.

Viewing cues

Once you have created a few cues, you may want to look at them. You can view stored cues in two ways, live in Stage mode, or just on the screen in Blind mode.

To view cues live, you must select the cue and play it back in a fader, see *Lesson 3: Playing back cues* for instructions.

To view a cue just on the screen, select Blind mode and enter the cue number you want. To view a different cue, press [Cue] and the new cue number that you want to see.

In Blind mode you can also use [+] and [-] to move through recorded cues, and cue parts, one at a time. Press [Cue]; thereafter [+] displays the next cue or part, and [-] displays the previous cue or part.

Copying cues

Once you have created a cue, you may copy it and give it a new number. This can be helpful if you want to create a cue based on one you have already recorded. You can copy cues in Stage or Blind modes.

Follow these steps to copy a cue:

1. Press [Blind] or [Stage]. You can copy a cue in either mode.
2. If you are working in Blind mode, press [Cue], then enter the number of the cue you want to copy. Or, if you are working in Stage mode, press [Cue], enter the number of the cue you want to copy, then press [Go].
3. In either Stage or Blind, once the cue is displayed, press [Rec] [Cue], the number of the new cue, and [Enter]. The new cue will be recorded; the original cue will not be affected.

Copying cue keystrokes:

Key	Action
[Blind] or [Stage]	Selects operating mode.
[Cue] [1] or [Cue] [1][Go]	Displays selected cue.
[Rec] [Cue] [2]	Copies Cue 1 and Cue 2.

Lesson 3

Playing back cues

Now that you have some cues, you're probably anxious to play them back. *Expression* has two sets of timed fader pairs that playback recorded cues. The left fader in each pair (faders A and C) controls upfades. The right fader in each pair (B and D) controls downfades.

You can playback cues one at a time through a single fader pair, or you can playback a different cue in each fader pair at the same time.

You can also play a cue in one pair, leave it there, and then play another cue in the second fader pair. This is one way to put two looks on stage at the same time.

For example, you may want to play a 10 minute sunset cyc cue in one fader pair while you play several cues during the same period downstage in the other fader pair.

This lesson includes the following sections:

- Selecting cues
- Timed fader pair and LED displays
- Playing back cues
- Go to a different cue
- Controlling fades manually
- Back key

Selecting cues

There are three ways a cue can be selected to playback on stage:

1) when a cue is playing, *Expression* automatically selects the next cue;
2) you select a cue manually; or 3) *Expression* automatically selects linked cues. You must be in Stage mode to select cues to playback.

When one cue is playing, *Expression* assumes that you want the next consecutive cue to play next. To play the next cue, press either [Go] key. If you are working in Stage mode, you see the cue running on the monitor. You can also run cues from Blind by pressing [Go].

To select a cue out of sequence, press [Cue], and enter the cue number. Then press either [Go] to start playing the cue.

Linked cues begin playing automatically. When you play a string of linked cues, or a chase loop, you only need to start the first cue.

Timed faders and LED displays

Each fader has a strip of LEDs next to it. When running a timed crossfade cue, the lit LEDs indicate how much of the cue has run. This is displayed as a percentage. For example, when the LED's are at **5**, 50 percent of the cue has run.

In default operation, *Expression's* faders function in level override mode. In level override faders control the percentage of completion of the fade, and can be used to take manual control of fades. Alternatively, you may choose to use the faders in proportional rate override. In this mode the faders control the rate of the fade, with the A and C faders controlling the upfade rate and the B and D faders controlling the downfade rate.

For information on taking manual control of fades, see the section titled *Controlling fades manually* later in this lesson.

Playing cues back

To playback the cues you created in Lesson 2, follow these steps:

1. Press [Stage] to display Stage mode.
2. Press [Cue] to indicate that you want to select a cue.
3. Enter the cue number you want to playback. To playback cues you recorded from Lesson 2, press [1][.][1].
4. Press either [Go] key. Cue 1.1 begins. *Expression* assumes that you want to play cue 2 next.
5. Press [Go] to start cue 2.

If you press [Go] before a cue finishes playing, the previous cue stops, and the new cue begins from the levels at which the previous cue was interrupted.

Go to a different cue

To playback a cue other than the selected (highlighted) cue on the cue sheet, follow these steps:

1. Press [Cue].
2. Enter the cue number you want to play next.
3. Press [Go].

Hint: If you want to force a cue to its recorded levels immediately, without waiting for the recorded fade times, when fade starts, pull faders down to meet lit LEDs, then push them to 10 (100 percent).

Controlling fades manually

Expression provides two fader modes to take manual control of cue playbacks with the AB and CD fader pairs: level override and proportional rate override.

In both fader modes, setting faders at **10** before pressing [Go] plays cues back as recorded; setting faders at **0** before you press [Go] gives you manual control of fade from the beginning of cue. In level override mode, if you start a cue and want to take manual control, slide faders down to meet the lit LEDs. *Expression* gives you control of the fades. In proportional rate override mode, you must move the faders below **5** to take manual control.

*Hint: If you start a cue, and the performers skip ahead to the next cue, you have two options for speeding up to the next cue. If you do not need the current cue to reach its full intensity level settings, press [Go] to interrupt the current cue and begin the next one. However, if you need the current cue to reach its full level settings, push the slides down to the lit LEDs and then back up to **10** immediately. Then press [Go] to start the next cue.*

Level override

Level override is *Expression's* default operating mode. In level override, you can use the faders to take manual control of fade levels. When you take manual control, the movement of the faders controls the completion of the fade.

When you move the faders to a point lower than **10** in level override mode, the cue runs until it reaches the fader level setting. You can set the level before you start the cue running, or move the faders once the fade starts. The fade stops when it reaches the level at which the faders are set, and you then have manual control of fade rates. For example, if you set faders at **8**, the cue will play back to 80 percent of its recorded levels.

Proportional rate override

If you prefer, you can select proportional rate override from the System Settings Menu. In proportional rate override, the position of the faders determines the *rate* at which a fade progresses. The left fader controls the upfade rate; the right fader controls downfade rate.

The fader setting determines the percentage of the recorded rate at which the cue plays back. To take manual control of the fade rate, move the faders to a point below **5**, then move the faders to the desired position. The percentage is determined by the level at which the faders are set. Setting a fader at **0** stops the fade; setting it at **5** sets the fade rate at 100 percent of the recorded rate. If you set a fader at **10**, the fade is instantaneous. You can set the level before you start the cue running, or move the faders once the fade starts.

Selecting fader operating mode

Follow these steps to select the desired fader mode:

1. Press [Setup].
2. Select 6, **System Settings Menu**, and press [Enter].
3. Select 6, **Level/Proportional Rate Override**, and press [Enter].
4. Press [0] to select level override mode, or press [1] to select proportional rate override mode.

Manual control of linked cues

When you play back linked cues, the left fader in each fader pair controls intensity levels; the right fader controls the playback rate. When you begin a linked cue sequence with the right fader at **10**, *Expression* plays it back at the recorded rate. The LED strip on the right fader indicates that playback is at recorded rate by holding at **5**. To take manual control of the playback rate, move the fader down to **5**, then move it up or down to adjust rate. Moving the fader control to **10** makes playback instantaneous; moving it to **0** stops playback.

If right fader is set at anything other than **10** when you start the autoload, the linked cues or effects playback at the rate set on the fader.

Modifying cues on stage

To modify and record a cue on stage, follow these steps:

1. Press [Stage].
2. Press [Cue], and enter cue number.
3. Press [Go] to playback cue.
4. Push faders down and back up to avoid fade times.
5. Modify cue.
6. Press [Rec].
7. To rerecord as same cue, press [Enter].

To record as a new cue, enter new cue number, and press [Enter].

8. Release captured channels.

Note: If you rerecord as same cue, modifications are reflected in fader. If you record the cue with a new number, modifications are not reflected in the fader; you may want to run cue through fader before you release channels if you don't want to lose the look from stage.

Update cue

The preceding steps allow you to record the entire on stage look into the modified cue. To add only *selected* channels to the cue, use the Update cue feature.

1. Press [Stage].
2. Press [Cue], and enter cue number.
3. Press [Go] to playback cue.
4. Push faders down and back up to avoid fade times.
5. Add channels and set levels, or modify levels of existing channels.
6. Press [Update] [Cue] [Enter] to update the existing cue, or [Update] [Cue] a new cue number, and [Enter] to record the updated cue as a new cue.
7. To rerecord as same cue, press [Enter].

To record as a new cue, enter new cue number, and press [Enter].

8. Release captured channels.

Back key

The back key replays the most recently played cue, regardless of the order in which the cues were recorded in the cue sheet. It then plays subsequent cues in reverse numerical order. For example, if you play cues one, two, three, twenty-two, and sixteen, then press [Back], cue sixteen will fade into cue twenty-two. If you press [Back] again, cue twenty-one will play, not cue three.

Cues are played back using the fade and wait times recorded with the cue.

Back allows you to play back cues loaded in either fader pair. If you are using only one fader pair, you need only press [Back] to replay the previous cue. If you have cues loaded into both fader pairs, you must press [Back] then the [Go] button below the desired fader pair. If you play cues one, two and three in the AB fader pair and cues six, seven and eight in the CD fader pair, pressing [Back] then the AB [Go] plays back cue two; pressing [Back] then the CD [Go] plays back cue seven.

Note: Each time you press [Back], Expression resets the cue sheet. The cue replayed with Back becomes the first cue in the cue sheet. If you then press [Go] without first pressing [Back], the next numerical cue plays.

Clearing fader pairs

Each timed fader pair is equipped with a blue [Clear] key. To clear a cue from the fader pair, press the appropriate [Clear] key. Faders will clear immediately unless you have reset the default fader clear time. For instructions on changing fader clear time, see page 3 - 15.

Lesson 4

Working with submasters

Expression is equipped with 24 submaster potentiometers, or *pots*. A submaster is a set of channels recorded at levels to create a look. The submaster pot gives you manual control for the recorded look. You cannot play submasters back through autofader pairs. Submasters allow you to save looks that you use often. You can use submasters as building blocks when you create cues or other submasters. For example, you might create a different submaster for each cyclorama wash; another submaster might include practicals. Or, you might choose to create a series of submasters for each area of your set.

Each submaster consists of a slide control and a bump switch. The slide control allows you to bring the submaster look up manually. The bump switch allows you to flash the submaster to its full recorded level or to begin its programmed fade time, if any.

When a slide pot is set at **0**, the submaster is at zero percent of its recorded level. To increase submaster level, push pot up. When pot is set at **10**, submaster is at 100 percent of recorded level.

Expression submasters are pile-on submasters. That is, if several outputs (timed playback faders and other submasters) include the same channel, the highest output level overrides all others. However, captured channels and inhibitive submasters override pile-on submaster levels.

Any specific channel may be included in as many pile-on submasters as you choose.

Half of *Expression's* submasters can be recorded as either pile-on or *inhibitive* submasters. Inhibitive submasters limit the intensity level for the channels recorded in it. See page 4 - 43 for more information on inhibitive submasters.

Naming submasters with expanded memory

If you have installed the expanded memory option, you can use a standard PC XT compatible, alphanumeric keyboard to assign names to submasters. See page 7 - 3 for more information on using the alphanumeric keyboard to name submasters.

This lesson includes the following sections:

- Submaster pages
- Creating pile-on submasters
- Recording submasters on a different page
- Adding fade times to submasters
- Controlling submaster fades manually
- Modifying pile-on submasters
- Creating inhibitive submasters
- Recording inhibitive submasters on a different page
- Modifying inhibitive submasters
- Using Update to modify submasters
- Copying submasters
- Deleting submasters
- Submaster sheet

After creating cues in Lesson 2, you should be well acquainted with several methods for creating looks on stage. In this lesson, we won't trouble you with reading instructions on selecting channels and setting levels since you already know how to do that. Instead, we'll concentrate on how creating submasters is different from creating cues.

Submaster pages

Expression has two *pages* of submasters. Each page can hold a full set of recorded submasters, one in each pot. This doubles the number of recorded submasters available.

Expression displays the message **Page 1 Loaded** (or **Page 2 Loaded**) in the Page Display window to indicate which page is currently active. To switch pages, press [Page]; enter the page number you want, and press [Enter].

The message indicates the new page number and displays the message **Loading** instead of **Loaded**.

When you load a new page, any submasters set at a level above zero remain on stage until you pull them down to zero. This prevents the stage from going black when you switch pages. Submasters remaining from the previous page are indicated by flashing bump switch LEDs.

Submasters on the new page are not loaded into pots until you pull them down to zero. The message **Loading** remains on the screen until all submasters on the new page are loaded.

Note: When you read a new show into the console from a disk, the console loads the same page number that was loaded from the previous show.

If any submasters are on stage when you read a new show into the console, they will remain on stage until you pull pots down to zero. Submaster LEDs flash to indicate that the associated submaster levels are not from the currently loaded page.

Creating pile-on submasters

Creating a submaster is as easy as creating a cue. You can create submasters in Stage or Blind mode. To create a submaster, follow these steps:

1. Select channel and level settings as you did for cues. See *Lesson 2, Creating cues* if you need a review. You can use channel settings from other submasters or cues by bringing up a recorded look, then modifying as you desire.
2. Press [Rec], and press the bump switch where you want to record the submaster.

Or, press [Rec] [Sub], then enter a submaster number, and press [Enter].

3. Press [Rel] to release captured channels.
4. Push the submaster pot up. The channels you recorded come up at the proportionate levels you recorded.

Recording submaster on a different page

You may record a submaster to a page other than the one currently loaded or loading. For example, if you have page one loaded, you can create a look on stage and record it to page two if you wish. To do so, follow these steps:

1. Create a look on the screen.
2. Press [Rec].
3. Press [Page].
4. Enter the page number on which you want to record submaster.
5. Press the bump switch of the submaster in which you want to record the look.

Adding fade times to submasters

Bump switches let you add upfade, downfade and wait times to submasters. When you record fade times for a submaster, you can play the recorded fade with the bump switch or retain manual control with the sliding fader.

You can add fade times to a submaster from any mode. To add fade times to an existing submaster, follow these steps:

1. Press [Sub] to indicate that you are selecting a submaster.
2. Enter the submaster number to which you want to add fade times.
3. Press [Time].
4. Enter upfade time in minutes and seconds or as a fraction of a second as a decimal, and press [Enter]. Upfade time cannot exceed two minutes.
5. Enter wait time, and press [Enter]. Wait time is the length of time the submaster holds a look before starting to downfade.

To enter an infinite wait time, press [-]. If you record a submaster with an infinite wait time, the submaster will not fade out until you press the bump switch again.

If you do not enter a wait time, upfade runs as long as you press the bump switch; the downfade begins when you release it. Therefore, when you haven't recorded a wait time, and if you don't hold the bump switch for the duration of the fade time, channels do not reach their full recorded levels.

Also, if you press the bump switch and hold it beyond the length of the upfade time, the downfade does not begin until you let the switch up.

Note: The wait time for a submaster begins at the end of the upfade, versus a cue wait time that begins at the start of the upfade.

6. Enter downfade time in minutes, seconds or as a fraction of a second as a decimal. Downfade cannot exceed two minutes.
7. Press the bump switch to start submaster upfade. The submaster runs as described above.

Controlling submaster fades manually

When a timed submaster pot is set at zero and you press the bump switch, recorded fade times playback as you recorded them. However, you can take manual control over fades, much as you can for cue fades.

You can increase the upfade rate by pushing the pot ahead of the programmed fade rate. You can force the downfade to start early by pressing the bump switch, but you cannot change the fade time.

Once a timed submaster is running, pressing the bump switch changes the direction of the fade. For example, if half of the upfade is complete, pressing the bump switch starts the downfade from 50 percent. If a downfade is running, pressing the bump switch begins an upfade again from the current level.

Hint: You cannot cancel a timed submaster once it's started. However, you can force the channel levels to zero with the following key sequence. Press [Group] [Sub] and the number of the running submaster. Then press [Inhib Sub] and any available inhibitive submaster bump switch. This puts all channels included in the running submaster in an inhibitive submaster. Pull inhibitive submaster level to zero.

Modifying pile-on submasters

To modify a recorded pile-on submaster, follow these steps:

1. Press [Blind] to display Blind mode.
2. Press [Sub] and the number of the submaster you want to modify.
3. **To add or change channels:**
Select channel numbers and set desired levels.

To change all channels proportionately:

Press [Group], [Sub] and enter the submaster number you are modifying. This selects all channels at current levels. Move the fader wheel to proportionately modify levels.

To delete channels:

Select channels and press [Clear] to set them to 00.

4. Press [Rec] [Enter].

Creating inhibitive submasters

Inhibitive submasters allow you to limit the intensity level for a group of channels. When an inhibitive submaster pot is on 10 (100 percent), the channels are not inhibited. As you pull the pot down, the channels' levels are limited to the percentage to which you set the submaster.

For example, assume you select channels 1 through 15 for an inhibitive submaster. As long as the submaster is set at **10** (100 percent), channels 1 through 15 are not affected. When you pull the submaster down to 5 (50 percent), channels 1 through 15 are limited to 50 percent of any other output settings.

Each channel can be included in only one inhibitive submaster. If you assign a channel to an inhibitive submaster that is already included in another, *Expression* removes it from the first one, and adds it to the submaster that you most recently recorded.

Inhibitive submasters affect timed fader pairs and other submasters. Captured channels are not affected by inhibitive submasters, but cues playing back through timed fader pairs are.

*Remember, leave inhibitive submasters at **10** (100 percent) unless you want to inhibit channels. Otherwise channels may be missing from your cues. If you seem to be missing some channels, check your inhibitive subs!*

You can record submasters 13 through 24 either as pile-on or inhibitive. A lit red LED in the bump switch indicates that an inhibitive submaster is recorded.

Follow these steps to create an inhibitive submaster:

1. Press either [Stage] or [Blind].
2. Press [Chan] to indicate that next number entered will be a channel.
3. Enter the channel numbers you want to include in the submaster using the numeric keypad, [And] and [Thru].

Expression saves only selected channels when you record an inhibitive submaster (on a color monitor, selected channels are displayed in yellow). If unselected channels are also displayed, they will not be included in the submaster.

4. Press [Rec] [Sub] [-] to indicate that you want to save selected channels in an inhibitive submaster.
5. Press the bump switch of the submaster you want to record.

Red LED in a bump switch indicates that you have recorded an inhibitive submaster.

Recording inhibitive submasters on a different page

You may record an inhibitive submaster to a page other than the one currently loaded or loading. For example, if you have page one loaded, you can create an inhibitive submaster and record it to page two. To do so, follow these steps:

1. Select the desired channels.
2. Press [Rec].
3. Press [Sub] [-].
4. Press [Page].
5. Enter the page number on which you want to record the inhibitive submaster.
6. Press the bump switch of the submaster you want to record as an inhibitive submaster.

Modifying inhibitive submasters

You can not use the [Update] key to modify inhibitive submasters. To modify an inhibitive submaster, follow these steps:

1. Press [Blind].
2. Press [Sub], and enter the submaster number.

Note: If you press [Rec] [Enter], Expression deletes the submaster.

3. Select the channels you want to add or remove from the submaster.
4. Press [Rec] [Sub] [-] and the submaster bump switch to add the selected channels. Or, press [Clear] [Rec] [Sub] [-] and the submaster bump switch to delete them.

Using Update to modify submasters

In Stage mode, [Update] allows you to modify, or add channel levels to, a recorded submaster without recording the entire stage look to the submaster you are modifying.

Follow these steps to update a submaster:

1. Press [Stage] to display Stage mode.
2. Select and set desired levels of the channels you want to add to the submaster.
3. Press [Update] [Sub], and enter the number or press the bump button of the submaster you want to update.

Copying submasters

You may want to copy a submaster or use submasters as building blocks for new submasters. To copy a look from one submaster to another in Stage, follow these steps:

1. Press [Stage].
2. Set submaster pot(s) that you want to copy at desired level.
3. Make any additional adjustments you want, such as selecting channels to add, playing back cues through fader pairs, bringing up other submasters, or selecting groups.
4. Press [Rec].
5. Press [Page], and enter the page number onto which you want to copy the submaster, if it is not the currently loaded page.
6. Enter new submaster number, and press [Enter]. Or, press the submaster bump switch.

Deleting submasters

You must be in Blind to delete individual submasters. To delete all submasters and all other show information, you can use the Set Up Menu option *Diagnostic system clear*. It is described on page 8 - 21.

To delete submasters, follow these steps:

1. Press [Blind] and then [Sub].
2. Enter submaster number you want to delete.
3. Press [Clear].
4. Press [Rec] to delete the submaster or [Clear] to cancel the action.

Submaster sheet

Submaster sheet is a feature of *Expression's* expanded memory option. It is available only when expanded memory is installed.

Submaster sheet allows you to view submasters on the display screen. All 24 submaster pots per page are represented on the submaster sheet. Submasters with recorded levels are displayed in green; those with no recorded levels are displayed in blue. Inhibitive submasters are displayed in red. If a submaster is recorded with specified upfade and downfade times, the times are displayed. Alphanumeric names are also displayed if this option is installed.

The submaster sheet lists all 24 submasters. Page one and two are displayed separately.

Follow these steps to display submaster sheet:

1. Press [Blind] [Sub] [Page] to display submaster sheet, page one.
2. Press [Page] to toggle between submaster page one and page two.

Lesson 5

Saving your show on disk

You should always make at least one back up copy (if not two) of each show you are working on. Back up copies are stored on standard 3.5-inch, double-sided, double-density, computer disks. We suggest that you make back up copies of your work after every session during which you modify a show.

When you record a show to disk, all information that you have entered in the console is saved. This includes all system settings, softpatch, cues, groups, and submasters.

To make a backup copy of your work requires three steps, (each is included in this lesson):

- Format a standard double-sided, double-density 3.5-inch, disk on the console
- Record show on formatted disk
- Verify that show was properly recorded

For more disk information and instructions on reading a show from disk, see *Chapter 6, Using print and disk options*.

Naming shows

If you have the expanded memory option and alphanumeric keyboard, you can assign alphanumeric names to shows. For information on naming shows, see page 7 - 4.

Formatting disks

You must format disks in a console before you can record shows on them. *Expression* cannot record shows on unformatted disks or disks that are formatted in a personal computer. Each disk can hold two shows.

Warning: Formatting a disk erases all information recorded on disk. It does not affect the current show in console.

To format disk, follow these steps:

1. Insert standard double-sided, double-density 3.5-inch computer disk in disk drive.
2. Press [Set Up].
3. Select 5, **Format disk**, and press [Enter].
4. Begin formatting by pressing [Enter].

Or, cancel format operation by pressing [Clear]. You cannot cancel format after you press [Enter].

Recording a show on disk

To record a show from the console memory to a disk follow these steps:

1. Insert a formatted disk in disk drive.
2. Press [Set Up].
3. Select 1, **Record show on disk**, and press [Enter]. *Expression* displays the screen illustrated below:

```
TO RECORD ONTO DISK, SELECT SHOW NUMBER, THEN PRESS "ENTER"  
TO ABORT, PRESS "CLEAR"  
  
SHOW 1:          RECORDED  
SHOW 2:          RECORDED  
  
(USE DOUBLE SIDED, DOUBLE DENSITY DISK ONLY)
```

If either show is currently recorded on disk, the screen displays the message, **Recorded**, or the date recorded if you have the Real Time Clock option. If no show is recorded on disk, *Expression* displays the message, **Not recorded**.

4. Select either show and press [Enter]. If the show number you select is already recorded, the new show will overwrite the old show.

Or, press [Clear] to cancel the operation.

Verifying a show on disk

The **Verify show on disk** option compares a show that is recorded on disk with the show in memory. *Expression* indicates if the shows are identical or not.

You may want to use this option to verify that your disk is not damaged and that your show was copied to the disk without any errors. You might also use it to compare backup copies of a show with the current version in memory.

To compare a show recorded on disk with the show in memory, follow these steps:

1. Insert disk in disk drive.
2. Press [Set Up].
3. Select 3, **Verify show on disk**, and press [Enter].

If either show one or two is currently recorded on disk, the screen displays the message, **Recorded**, or the date recorded if you have the Real Time Clock option. If no show is recorded on disk, *Expression* displays the message, **Not recorded**.

4. Select either show one or two, and press [Enter]. *Expression* compares the show you selected from disk with the show in memory.

If you receive a **Verify failed** message, you may have any of the following problems: show on disk is not the same as show in memory; disk is damaged; console did not record show to disk correctly.

If you receive this message, repeat the read or record operation immediately. If it recurs, try a new disk.

The message **Configurations differ, cannot verify** indicates one of the following: show on disk was saved on a different type of ETC console or different software version; show on disk has different **system settings** (such as softpatch, numbers of dimmers and channels) than show in console.

chapter 5

learning advanced techniques

The lessons in this chapter address advanced features that allow you to use *Expression* more efficiently and to create more complex lighting effects.

Before you start the lessons you should know how to create and play back cues and submasters and how to take manual control of timed fades. *Chapter 4, Learning the basics* includes lessons on these tasks.

The lessons in this chapter will teach you how to:

- Create and run multipart cues
- Use Track record function
- Use Track Sheet
- Use Group feature
- Create and run effects
- Create and run subroutines
- Create and run autoloads
- Create and run macros

Each of these features is described briefly below.

Multipart cues

A multipart cue is a cue that consists of two or more parts. Each part is in effect an individual cue with its own levels and upfade and downfade times. A multipart cue allows you to simultaneously run and control up to eight discrete looks through one multipart cue. Each part may have its own fade and wait times. A multipart cue takes up the equivalent storage space of three cues.

Track record function

Track is a record function that allows you to modify recorded cues and designate new levels for the displayed cue only or to track them forward until a different level is encountered.

It also allows you to quickly modify groups of cues and add channels to cues. You can also use it to create a new cue from the previous one, by pulling all levels forward into the Blind display of the new cue.

Track Sheet

Track Sheet displays one channel's intensity level settings for all recorded cues. From it, you can quickly see tracks for any individual channel. You can then select a cue or a group of cues from the Track Sheet and modify channel levels. Track Sheet provides one means for tracking channels through allfade cues.

Group

Expression's Group feature lets you store groups of channels with proportional level settings. Group numbers are independent of cue and submaster numbering.

Effects

The Effects feature lets you create special lighting effects such as lightning, strobes and chases for marquees or runways.

Subroutines

A subroutine is a cue that controls the playback of a series of recorded cues. Subroutines are similar to linked cues, except that they have more playback options. Subroutines allow you to link and playback cues with modified fade times without affecting originally programmed fade times.

Autoloads

The Autoload feature allows you to load and play cues or effects from both sets of faders at the same time. You can save up to 25 autoloads per show.

Macros

A macro works like a redial button on a telephone. With it you can store a series of keystrokes and later replay it with a simple keystroke. Macros simplify complex tasks that you perform often. *Expression* can save up to 125 macros or 640 if you have expanded memory.

Lesson 1

Working with multipart cues

A multipart cue is a cue that consists of up to eight parts, each of which is essentially an independent cue. A multipart cue allows you to control the levels and timing of more than one group of channels at a time. Each part of a multipart cue may consist of any number of channels, but a channel may only be included in one part of a given multipart cue. If you record a channel that was previously included in a different part, the channel will appear in the new part, and will be removed from the previously created part.

Multipart cues are stored like normal cues in the console's memory and on disk, but each multipart cue takes up the same memory space as three standard cues.

Wait times in multipart cues

Upfade and downfade wait times allow you to program upfades and downfades that do not start immediately when you start the multipart cue. When you run a multipart cue with wait times, some parts may start immediately and others may start up to 99:59 minutes later, depending on the assigned wait time.

The total duration of a multipart cue is measured from when the [Go] button is pressed to when the last fade ends.

Note: Fade and wait times cannot be assigned to a part until the part is recorded. Either record a part and then assign times to it, or record the entire multipart cue, then assign times to all its component parts at once.

Creating a multipart cue

Follow these steps to create a multipart cue:

1. Press [Stage]. *Expression* displays the Stage mode screen and prompts you to enter a channel number.
2. Enter channel number(s) for the first part with numeric keypad.
3. Set intensity levels by pressing [At] and entering a two-digit level, moving the fader wheel, or pressing [+] and [-].
4. Press [Rec]; then enter the number of the cue you wish to record with the numeric keypad.
5. Press [Step/Part]; then enter the number of the part you wish to create with the numeric keypad. Parts can be assigned numbers one through eight and can be created in any sequence you like.
6. Press [Enter].
7. Press [Time] if you want to assign upfade, downfade and/or wait times to the part.

Note: If you do not assign times to a part, Expression will automatically assign five second upfade and downfade times to it. No wait time will be recorded.

8. Enter an upfade time between .1 second and 99:59 minutes and press [Enter]. You can enter time either in minutes and seconds, or as a fraction of a second in decimal format. For example, all of the following are acceptable: .2, 00:12, 5.5, 5:30.
9. Enter a downfade time, if different from the upfade time you selected. If you do not enter a time, *Expression* assumes you want the same time.

10. Enter upfade wait time. Upfade wait time is the length of time after the multipart cue starts before the upfade. If you do not enter an upfade wait time, *Expression* assumes you want an upfade wait time of zero.
11. Enter downfade wait time. Downfade wait time is the length of time after the multipart cue starts before the downfade. If you do not enter a downfade wait time, *Expression* assumes you want an downfade wait time of zero.
12. Repeat steps 2 through 11 for each part you want to create.

Note: You do not need to rerecord the part to add fade and wait times.

Converting a standard cue to a multipart cue

If you have already created a single-part cue, *Expression* allows you to reconfigure it as a multipart cue. You can convert a standard cue to a multipart cue in either Stage or Blind mode.

As you break the cue into parts to convert it to a multipart cue, *Expression* automatically creates cue part number eight. Any channels not included in the first recorded part are automatically assigned to part eight. As channels are assigned to new parts, they are automatically deleted from part eight.

Follow these steps to convert a standard cue to a multipart cue:

1. Press [Blind] or [Stage] to display the Blind or Stage mode screen.
2. Enter the cue number.
3. Press [Chan]; then select the desired channels for a specific part.
4. Use the numeric keypad, level wheel or [+] [-] keys to enter the desired level setting.
5. Press [Rec] [Step/Part]; then enter the part number with the numeric keypad.
6. Press [Enter].
7. Repeat steps three through six to create each part.

Note: When all of the channels are assigned to a part, part eight is automatically deleted.

Editing a multipart cue

Once you have created a multipart cue, you can add or delete channels from the parts, change channel levels, or change fade and wait times.

Adding, deleting and modifying channels

Follow these steps to make changes to a multipart cue:

1. Press [Blind]. *Expression* displays the Blind mode screen. The [Cue] LED lights, prompting you to enter a cue number.
2. Enter the cue number.
3. Press [Step/Part]; then press [+] or [-] until the part you want to edit is displayed.

Note: When you initially display a multipart cue, the channels that are tracking from the previous cue are displayed in green; those that are at new levels are displayed in blue. When you press [Step/Part] to display a part, channels that make up the selected part are displayed in blue; channels that make up other parts of the multipart cue are displayed in green.

4. Press [Chan], and select the channels you want to modify.

To add channels

Set intensity by level of new channels by pressing [At] and entering a two-digit level, moving the fader wheel, or pressing [+] and [-].

To delete channels

Set channel levels to zero by pressing [At] [0] [0].

To change level settings

Set new intensity level by pressing [At] and entering a two-digit level, moving the fader wheel, or pressing [+] and [-].

5. Press [Rec] [Enter] to record the modified part.

Modifying fade and wait times

If you do not assign fade and wait times to a part, *Expression* automatically assigns five second upfade and downfade times to it. No wait time will be recorded. Follow these steps to assign fade and wait times to parts in a multipart cue:

1. Press [Blind]. *Expression* displays the Blind mode screen. The [Cue] LED lights, prompting you to enter a cue number.
2. Enter the cue number.
3. Press [Step/Part]; then press [+] or [-] until the part you want to edit is displayed.
4. Press [Time] .
5. Enter an upfade time between .1 second and 99:59 minutes and press [Enter]. You can enter time either in minutes and seconds, or as a fraction of a second in decimal format. For example, all of the following are acceptable: .2, 00:12, 5.5, 5:30.
6. Enter a downfade time, if different from the upfade time you selected. If you do not enter a time, *Expression* assumes you want the same time.
7. Enter upfade wait time. Upfade wait time is the length of time after the multipart cue starts before the upfade begins. If you do not enter an upfade wait time, *Expression* assumes you want an upfade wait time of zero.
8. Enter downfade wait time. Downfade wait time is the length of time after the multipart cue starts before the downfade begins. If you do not enter a downfade wait time, *Expression* assumes you want a downfade wait time of zero.

Lesson 2

Track record function

The Track record function records the levels currently displayed on the screen in a cue, and allows you to create tracks into subsequent cues. A track is created by a channel whose level does not change through a series of consecutive cues. [Track] creates tracks by pulling channel levels from the previous cue (in Blind mode), or by adding tracks to existing cues (in either Blind or Stage).

Cue levels are usually set live, working in Stage mode. When you record a series of cues, you typically record the first cue of the sequence. The second cue is built from the first with some of the channels changing, but many remaining the same. The third cue is built from the second and so on, until a major change, such as a black out, is recorded.

This procedure results in many channels being set to a level in one cue and staying at that level for several cues. These *tracks* develop regardless of the record function (Record or Track) you use to record the cues.

Channels levels displayed in blue on the Blind screen indicate that the channel has moved to a new level in that cue. This serves as a blocking level when you create a track. Channel levels displayed in green on the Blind screen indicate that the recorded level is the same as in the previous cue.

The following examples demonstrate how Track works, and compare it to how Record works. The examples include five cues, each with five channels.

When a channel changes level from one cue to the next it is printed in **bold** on the following pages; tracked channels are printed in regular print. This is similar to how Blind mode displays levels on a color monitor – channels that change intensity are displayed in bright blue; tracked channels are displayed in green.

Using record to create tracks

In Stage mode, the following keystrokes create the five cues illustrated below. Each cue adds channels to the previous cue. The example uses Record to record the cues.

```
Cue 1 [Chan] [1] [Full] [Rec] [1] [Enter]
Cue 2 [Chan] [2] [Full] [Rec] [2] [Enter]
Cue 3 [Chan] [3] [Full] [Rec] [3] [Enter]
Cue 4 [Chan] [1] [At] [2][5] [Chan] [4] [Full] [Rec] [4] [Enter]
Cue 5 [Chan] [1] [Thru] [4] [At] [0][0] [Rec] [5] [Enter]
```

These keystrokes produce the results illustrated in Figure 1.

	Cue 1	Cue 2	Cue 3	Cue 4	Cue 5
Channel 1	FF	FF	FF	25	00
Channel 2		FF	FF	FF	00
Channel 3			FF	FF	00
Channel 4				FF	00
Channel 5					

Figure 1.

Notice the horizontal tracks developed by keeping a channel at the same level through a number of cues. For example, channel 1 tracks from cue 1 to cue 3. When a channel is not set at any level (such as channel 5 above) it is considered tracked at clear.

Note that channels remain at set levels while you program the series of cues because they are captured and have not been released.

Recording modified cues

The difference between Record and Track is apparent when you modify a cue or insert a new cue between two existing cues. Record and Track produce different results.

The following keys were pressed to release captured channels and play back cue 1.

[Stage] [Rel] [Rel] Release captured channels.
 [Cue] [1] [Go] Play back cue 1.
 [Chan] [1] [At] [5][0] Modify channel 1 to 50 percent.

With cue 1 in a fader pair, channel 1 is modified to 50 percent. To change a channel level that affects only the cue you modify, use [Rec]. Modify the cue; press [Rec]; enter the cue number, and press [Enter]. Only the current cue is modified. The track that encompasses the channel is interrupted but continues in the following cues at the originally tracked level.

The results of modifying cue 1 and using [Rec] are illustrated in Figure 2.

	Cue 1	Cue 2	Cue 3	Cue 4	Cue 5
Channel 1	50	FF	FF	25	00
Channel 2		FF	FF	FF	00
Channel 3			FF	FF	00
Channel 4				FF	00
Channel 5					

Figure 2.

Note that channel 1 is not affected in cues 2 and 3. Also note that when you record a modified cue that is in a playback fader pair, the changes are reflected in the fader. That is, when you release the channels you have modified, they remain on stage.

If you change the level in the beginning or middle of a track, you may want the change to continue through the remainder of the original track. To *track* the level modification we just recorded in the example above use [Track] instead of [Rec] to record channel one as on the previous page. Press [Track], enter cue number, and press [Enter]. If you use [Track] rather than [Rec] to record the changes made to the cue illustrated in Figure 1, the results will be as illustrated in Figure 3 (versus the results from using [Rec] illustrated in Figure 2).

	Cue 1	Cue 2	Cue 3	Cue 4	Cue 5
Channel 1	50	50	50	25	00
Channel 2		FF	FF	FF	00
Channel 3			FF	FF	00
Channel 4				FF	00
Channel 5					

Figure 3.

The modified level is recorded in the current cue and carries through the entire track (cues 1 through 3).

Inserting cues

If you insert a cue in this sequence, Record and Track produce different results. Record saves changes only in the cue you insert; Track saves the changes you make and tracks them through the following cues.

The following keys were pressed to release captured channels and play back cue 1. With cue 1 in a fader pair, channel 4 is added at 50 percent. The new look is inserted as cue 1.1.

[Stage] [Rel] [Rel]	Release captured channels.
[Cue] [1] [Go]	Play back cue 1.
[Chan] [4] [At] [5][0]	Add channel 4 at 50 percent.
[Rec] [1][.][1] [Enter]	Inserts new look as cue 1.1.

Figure 4 displays the result inserting the cue using [Rec]. Notice the new channel is not added to the cues that follow it.

	Cue 1	Cue 1.1	Cue 2	Cue 3	Cue 4	Cue 5
Channel 1	50	50	50	50	25	00
Channel 2			FF	FF	FF	00
Channel 3				FF	FF	00
Channel 4		50	00		FF	00
Channel 5						

Figure 4.

Note that *Expression* enters a level of 00 percent for channel 4 in cue 2. This downfades the channel when cue 2 is played.

When you insert a cue with [Track] new channels track through the cues after it until *Expression* encounters a cue with a level previously recorded for that channel.

Pressing [Track] (rather than [Rec] as in the previous example) then [1][.] [1] [Enter] to insert and record the same cue 1.1 as above produces the results illustrated in Figure 5. Compare it to the results illustrated in Figure 4, in which the same cue was inserted using [Rec] rather than [Track].

	Cue 1	Cue 1.1	Cue 2	Cue 3	Cue 4	Cue 5
Channel 1	50	50	50	50	25	00
Channel 2			FF	FF	FF	00
Channel 3				FF	FF	00
Channel 4		50	50	50	FF	00
Channel 5						

Figure 5.

Channel 4 creates a track from cue after 1.1 until a prerecorded level interrupts it.

Blackout cues and tracking

Sometimes you may add a channel to a sequence of cues that has not used that channel yet. For example, you may want to add a channel to all cues in a scene. To do this, add the channel to the first cue in the sequence, and use Track to track the change through the remaining cues.

However, the last cue in sequence may be a blackout cue. When you track the channel, the new channel tracks until it runs into a different recorded level. To assure that channels are not tracked through a blackout cue, the allfade fade type records all unused channels in a cue at zero. This works as a roadblock for added tracks.

Figure 6 displays what happens when we track channel 5 through the sequence when cue 5 is a regular crossfade cue.

	Cue 1	Cue 1.1	Cue 2	Cue 3	Cue 4	Cue 5
Channel 1	50	50	50	50	25	00
Channel 2			FF	FF	FF	00
Channel 3				FF	FF	00
Channel 4		50	00		FF	00
Channel 5	FF	FF	FF	FF	FF	FF

Figure 6.

Channel 5 tracks through cue 5 and ruins the black out cue.

If cue 5 is an allfade, *Expression* records all unused channels at 00 percent. In the example below, an allfade enters 00 in channel 5, cue 5. When you track a channel through the sequence, the new channel will not track through the blackout cue.

To select the allfade type for cue 5, enter these keystrokes:

[Blind] [Cue] [5] [Type] [2] Selects allfade fade type.
 [Rec] [5] [Enter] Rerecords cue.

Now when we track channel 5 through the sequence, cue 5 acts as a roadblock for the track. The result is illustrated in Figure 7.

	Cue 1	Cue 1.1	Cue 2	Cue 3	Cue 4	Cue 5
Channel 1	50	50	50	50	25	00
Channel 2			FF	FF	FF	00
Channel 3				FF	FF	00
Channel 4		50	00		FF	00
Channel 5	FF	FF	FF	FF	FF	00

Figure 7.

For more information on cue fade types, see page 8 - 74.

Lesson 3

Track Sheet

Tracked channels are channels whose levels do not change from one cue to the next. The Track Sheet allows you to display one channel's settings for all recorded cues. At a glance you can see which cues have tracking levels for that particular channel. You can also use the Track Sheet to add or modify a tracked channel through recorded cues.

Track Sheet screen

The Track Sheet is illustrated and described on the next page. To display it press [Track Sheet]. Step-by-step instructions for using the Track Sheet are on the following pages.

1		2		3		4		5	
END MASTER 100%		CHANNEL 2		CUES 2 - 307		TRACK SHEET		CHANNEL 32	
20	21	22	23	24	25	26	27	28	
31 FF	32 FF	33 FF	34 FF	44 00	48 FF	48.1 00	90	90.1	90.2
90.3	90.4	90.5 FF	90.6 00	90.7	90.8	90.9	91	91.1	91.2
91.3	91.4	91.5	123	123.1	124 SUBR	126 SUBR	128 SUBR	128.1	129.1
130.1	151 SUBR	170	170.1	170.2	170.3	170.4	173	173.1 FF	173.2 00
173.3	300	300.1	300.2	300.3	300.4	300.5 FF	300.6 00	300.7	300.8
301	301.1	301.2	301.3	301.4	301.5	301.6	301.7	301.8	301.9
305.1	305.2	305.3	305.4	305.5	305.6 FF	305.7 00	305.8	305.9	306
306.1	306.2	306.3	306.4	306.5	306.6	306.7	306.8	306.9	307

5 SELECT CHANNEL TO BE TRACKED

If more cues are recorded than fit on one screen, press [Track Sheet] again to display the next screen of cues.

Track sheet description

① Grand Master setting

The Grand Master setting displays the master dimmer intensity level. With it you can control the maximum level of all channels. The Grand Master overrides all other settings.

② Channel display line

This line displays the current channel number and the range of cues displayed.

③ Keypad prompt window

This window indicates how the console will interpret the next number you enter from the keypad. For example, if you press [Chan], the keypad prompt window displays the message **Channel**, indicating that the console will read the next number you enter as a channel number.

④ Cue display

The cue display lists recorded cues and the level recorded in each.

⑤ Operator prompt line

The operator prompt line displays messages to guide you through Track Sheet functions.

Working with Track Sheet

With the Track Sheet you can track one channel at a time through any group of cues at any level, including zero. Track Sheet is useful when you want to track a channel through blackout cues, or when you want to complete a broken track. To track a channel, follow these steps:

1. Press [Track Sheet].
2. Enter channel number you want to track.
3. Press [Cue] to indicate that you want to select cues.
4. Select the cue number(s) that you want to track this channel through. Use [And] and [Thru] to indicate a range or group of cues. Press [+] and [-] to select the next or previous cue.
5. Enter the desired level using the fader wheel, [At], [+], [-], or [Full].
6. Press [Rec], [Enter] to record level settings.
7. To track a different channel, press [Chan] and enter the next channel number you want to display.

Hint: To track a channel at zero through all cues it is included in, press [Track Sheet], enter channel number, then press [Solo] [Solo].

Track Sheet keystrokes:

Key	Action
[Track Sheet]	Displays Track Sheet.
[5]	Selects channel five.
[Cue]	Indicates that you are going to enter cue numbers.
[2] [Thru] [5]	Selects cues two through five.
[At]	Indicates that you are going to enter intensity level.
[5][0]	Enters 50 percent intensity level.
[Rec] [Enter]	Records tracked channel in selected cues.

Lesson 4

Using Group

If you have combinations of channels you use often to create looks, you can save time by using [Group] to record them at a proportional levels. Once it is recorded, a group can be combined with other channels to create cues, submasters or effects. Unlike a cue, a group cannot be played back through a fader or potentiometer.

Group numbers are independent of cue numbers; however, each group stored is included in the 400 cue memory limit. Therefore, the sum of cues and groups cannot exceed 400. You can use numbers from 1 to 999.

Naming groups with expanded memory

If you have installed the expanded memory and alphanumeric keyboard options, you can assign names to groups. See page 7 - 4 for more information.

Creating groups

You can create groups in Stage, Blind and Fader modes. To create a group, follow these steps:

1. Select channels. You can use any of the following to select channels: recorded submasters; recorded cues, [Chan], [And] and [Thru], other groups.
2. Set desired intensity levels with [At] and keypad, fader wheel, or [+] and [-].
3. Press [Rec].
4. Press [Group].
5. Enter the group number you want to save.
6. Press [Enter].

Displaying groups on stage

To view a recorded group on stage, follow these steps:

1. Press [Stage].
2. Press [Group], and enter group number.
3. Move fader wheel to adjust channels in their proportional recorded levels, or press [Full] to set them at 100 percent of recorded level, or press [At] and a two-digit number to set them at a percentage of recorded levels.

Modifying groups

Expression allows you to modify groups in Blind or Stage modes though the process is different.

Modifying groups in Blind

Follow these steps to modify a group in Blind:

1. Press [Blind].
2. Press [Group] to indicate that you are entering a group.
3. Enter the group number you want to modify.
4. Press [Enter].

Warning: If you do not press [Enter] after [Group], Expression displays the current look as it is being modified by the group. To modify the group, you must press [Group], enter the group number, and then press [Enter].

5. Set or modify channel levels. Use [Full] to set levels to their full recorded levels, [At] to set them at a percentage of the recorded levels, or the fader wheel to have incremental control of levels.
6. Press [Rec] [Enter].

Modifying groups in Stage

To add the look on stage to a group in Stage follow these steps:

1. Press [Stage].
2. Press [Group] to indicate that you are entering a group.
3. Enter the group number you want to modify.
4. Set or modify channel levels. Use [Full] to set levels to their full recorded levels, [At] to set them at a percentage of the recorded levels, or the fader wheel to have incremental control of levels.
5. Press [Rec] [Group].
6. Enter the group number you are modifying.
7. Press [Enter].

Modifying groups using Update

Update allows you to modify a group in Stage mode by adding to, or modifying, only those live channels you specifically select. Unselected live channels will not be included in the group. The levels of channels already included in the group, but not selected, are not affected. Follow these steps to use Update to modify a group:

1. Create a look on stage.
2. Select the channels you want to record or modify, then set channel levels.
3. Press [Update] [Group], the desired group number, and [Enter].

Deleting groups

To delete a group in Blind, follow these steps:

1. Press [Blind].
2. Press [Group] to indicate that you are entering a group.
3. Enter the group number you want to delete.
4. Press [Enter]
5. Press [Clear] [Rec] to delete the group.

Copying groups

Once you have created a group, you may copy it and give it a name. This can be helpful if you want to create a group based on one you have already recorded. You can copy groups in Stage or Blind modes.

Follow these steps to copy a group:

1. Press [Blind] or [Stage]. You can copy a group in either mode.
2. If you are working in Blind mode, press [Group], then enter the number of the group you want to copy. Or, if you are working in Stage mode, press [Group], enter the number of the group you want to dcopy, then press [Go].
3. In either Stage or Blind, once the group is displayed, press [Rec] [Group], the number of the new group, and [Enter]. The new group will be recorded; the original group will not be affected.

Copying group keystrokes:

Key	Action
[Blind] or [Stage]	Selects operating mode.
[Group] [1] or [Group] [1][Go]	Displays selected group.
[Rec] [Group] [2]	Copies Group 1 as Group 2.

Using groups to modify cues or submasters in Blind

When you modify a cue or a submaster using a group in Blind, follow these steps:

1. Press [Blind]. *Expression* prompts you for a cue number.
2. Enter cue number, or press [Sub] and enter a submaster number to display the cue or submaster you want to modify.
3. Press [Group] to indicate that the next number entered will be a group.
4. Enter group number.
5. Press [Full] to set group channels to their full recorded levels, or press [At] and enter a level to set them at a percentage of the group's look.

Or, press [Enter] to impose only the group's proportions on the currently set levels.

The fader wheel adjusts levels in group's proportions.

6. Press [Rec], [Enter] to record the modified cue or submaster.

Using Group Sheet to display groups

Group Sheet is an expanded memory option. It allows you to list all recorded groups on screen. If you have named groups using the optional alphanumeric feature, group displays the names.

Follow these steps to display Group Sheet:

1. Press [Blind] [Group] [Page]. Group Sheet displays the first 32 recorded groups.
2. Press [Blind] again to display additional groups.
3. Press [-] to return to Blind, or press another stage display button to move to another display mode.

Lesson 5

Working with effects

The effects feature lets you create special lighting effects such as lightning, strobes and chases. Each effect can contain up to 10 steps. Each step can include up to 10 channels, high and low intensity level limits for those channels, and a fade or delay time between steps. Each effect can be programmed to run for .1 second to 99:59 minutes. Each effect plays back in one of the four styles described below. Effects are a type of cue, therefore they are included in the 400 cue limit.

When you play back an effect, the previously played cue remains on stage while the effect plays. It continues until you begin another non-effect cue.

Loop

Runs through steps consecutively, returns to the first step and repeats the loop. Channels flash rather than fade between steps. Loop is useful for creating marquee-type effects.

Bounce

Runs through steps in forward and then in reverse order. Channels flash between steps rather than fade. Bounce can be used for marquee- or runway-type effects.

Random

Plays steps back in random order. Channels flash to high and low levels; they do not fade. Random creates lightning, flashing, or strobe effects.

Ripple

Plays steps in random order, but unlike random, channels fade between steps. Ripple creates the effect of flames or water reflections.

Creating an effect

To create an effect follow these steps:

1. Press [Blind]. You must be in Blind to create an effect.
2. Press [Type] to display the fade type menu.
3. Select 3, **Effect**. *Expression* displays the following screen.

GRAND MASTER 100% NOT RECORDED		BLIND		TIME 00:01											
CUE STYLE	31	EFFECT LOOP	NEGATIVE	RUN TIME: ALTERNATE	INF BUILD										
STEP	CHANNEL					HIGH	LOW	TIME							
01	01					75	25	00:01							
02	02					FF	00	00:01							
03	03					75	25	00:01							
04	04					75	25	*00:01							
A FADER		B FADER		C FADER		D FADER		CUE/TYPE	UP/DOWN	WAIT	LINK	DELAY			
CLEAR		CLEAR		CLEAR		CLEAR		01	00:05						
1	2	3	4	5	6	7	8	9	10	11	12	SUBMSTR			
												02	00:05		
												03	00:05		
												04	00:05		
												44	00:00		
												48	00:00		
												48	00:00		
												90	00:05		
												48.1			00:00
												PAGE 1			
												LOADED			
												SELECT TIME			

4. Press [Chan], and enter channel number(s) you want to include in the first step. Then press [Enter].

Or, press [Group], enter a group number, and press [Enter] to enter all channels in that group. You can also select channels in cues and submasters by pressing [Group], then [Cue] or [Submaster], entering the cue or submaster number, and pressing [Enter].
5. Enter a two-digit high level. To set level at 100 percent, press [Full]. Or, press [Enter] to accept the displayed setting.
6. Enter a two-digit low level setting. Or, press [Enter] to accept the displayed setting.

7. Enter a delay or fade time between 00:00 and 99:59. This is the length of time before the effect moves to the next step. You can enter time either in minutes and seconds or as fraction of a second in decimal format. For example, all of the following are acceptable: .2, 00:12, 5.5, 5:30.
8. Press [Enter].
9. Press [Step/Part], and enter next step number. Then press [Enter].
10. Repeat steps four through eight to create remaining steps.
11. Press [Time] to specify a duration time for the effect.
12. Enter a duration time of between 00:00 and 99:59. This is the length of time the effect runs after pressing [Go]. You can enter time either in minutes and seconds or as a fraction of a second in decimal format. For example, all of the following are acceptable: .2, 00:12, 5.5, and 5:30.

Entering zero assigns an infinite duration time. Effect will run until it is cleared from the fader.

13. Press [Style], and enter one of the following codes to select a playback style. Playback styles are described on page 5 - 29.
 - 1 - Loop
 - 2 - Bounce
 - 3 - Random
 - 4 - Ripple
14. For each style, some or all of the following modifiers are available. Modifiers are listed at the top center of the screen. Use the left and right blue arrow keys to move the asterisk next to the modifier you want, then press [Enter] to select the modifier. If you do not select any modifiers, effect plays in standard mode.

Standard

Expression creates effects by holding channels at low levels and flashing them to their high levels to create effect.

Negative

When you select negative, instead of flashing channels to their high level to create an effect, channels remain at their high levels and flash to their low level to create the effect.

Alternate

This modifier alternates playing the steps back in standard and negative modes.

Build

The build modifier starts each sequence by setting all channels at their low levels. Each step flashes to full and stays there until the beginning of the next sequence playback.

15. Press [Rec], enter cue number, and press [Enter] to record the effects cue.
16. Play back an effects cue as you would a normal cue; press [Stage] [Cue], enter effect number, and press either [Go].

When you play back an effects cue, the left fader of the fader pair (A or C) controls intensity levels. The right fader of the pair (either B or D) controls the playback rate. When you begin an effect with the right fader at **10**, *Expression* plays it back at the recorded rate; the LED strip indicates 50 percent on the right fader.

To take manual control of the playback rate, move the fader to 50 percent. Then move the fader up or down to adjust rate; **10** is instantaneous playback through steps and **0** stops playback.

If right fader is set at any level other than **10** when you start the effect, it plays back at that adjusted rate.

Effects keystrokes:

Key	Action
[Blind]	Displays Blind mode screen.
[Type]	Displays Cue Type Menu.
[3]	Selects effects cue type.
[Chan]	Indicates next number entered will be a channel number.
[1] [Thru] [1] [0]	Selects channels one through 10.
[Enter]	Assigns channel one to step one.
[7][5] [Enter]	Enters 75 as high level.
[2][5] [Enter]	Enters 25 as low level.
[.][1]	Enters delay time of a tenth of a second.
[Step/Part]	Indicates next number entered will be a step number.
[2] [Enter]	Selects step two.
[2] [Enter]	Enters channel two.
[Enter]	Accepts current high level.
[Enter]	Accepts current low level.
[.] [1] [Enter]	Enters delay time of a tenth of a second.
[Time]	Indicates next number entered will be effect duration time.
[1][4][5] [Enter]	Enters duration time of one minute, 45 seconds.
[Rec] [6] [Enter]	Records effect as cue 6.

Inserting and deleting steps

To insert a step, select the step after which you want a new step inserted, and press [Step/Part]. To delete a step, select it and press [Clear].

Editing steps

To edit effects steps, follow these steps:

1. Press [Step/Part], and enter the step number you want to edit.
2. Use the arrow keys to highlight the field in the step you want to edit.
3. Enter the new time or number in the field. To add a channel to a step, enter the channel number, and press [Enter]. To delete a channel from a step, enter the channel number, and press [Clear].

Effects shortcuts

Expression assumes you want to organize channels in a pattern. Therefore, you can enter the numbers of steps and channel numbers you want, and create all your steps at once.

To create all your steps at once, press [Step/Part] [1] [Thru], and then enter the total number of steps you want. Then select all the channels you want in the effect by pressing [Chan] and the channel numbers you want in conjunction with [Thru] and [And].

Expression assigns channels to steps numerically until it reaches the last step; the next channel is assigned to the first step and so on until all channels are assigned.

For example, if you select steps 1 through 10, and then select channels 1 through 60, *Expression* assigns channels as illustrated below.

GRAND MASTER 100%		BLIND				TIME 00:03	
Q1E 31	EFFECT	NEGATIVE		RUN TIME: INF	BUILD		
STYLE	LOOP			ALTERNATE			
STEP	CHANNEL				HIGH	LOW	TIME
01	01	11	21	31	41	51	
02	02	12	22	32	42	52	00:03
03	03	13	23	33	43	53	00:03
04	04	14	24	34	44	54	00:03
05	05	15	25	35	45	55	00:03
06	06	16	26	36	46	56	00:03
07	07	17	27	37	47	57	00:03
08	08	18	28	38	48	58	00:03
09	09	19	29	39	49	59	00:03
10	10	20	30	40	50	60	00:03

All your steps will still be selected. When you enter high and low levels and delay time, all selected steps are affected. Remember that you can, but don't have to, enter up to 10 channels per step.

You can also select a range of steps by pressing [Step/Part] and then entering step numbers with [Thru] and [And].

Lesson 6

Working with subroutines

A subroutine is a cue that controls the playback of a series of existing cues. The subroutine feature lets you change fade rates for the subroutine without changing rates in the original cues.

You can use subroutines and effects to create similar looks. However, subroutines have some advantages over effects. Since each step of a subroutine is a cue with proportional levels, you can create loops or chases with proportional looks.

Also, since subroutine steps are actual cues, there is no limit to the number of channels you can use.

Styles

The following playback styles are available for subroutines. Styles are entered as steps. When the subroutine plays back, the steps play back in numeric order, until the subroutine reaches a style step. The style step then determines which step will play back next.

Loop

Runs through steps until Loop step, returns to first step, and repeats sequence for the number of times you specify.

Bounce

Runs through steps until subroutine reaches Bounce step, then runs through steps in reverse order. Plays back in this pattern for the number of times you specify.

Jump to cue

Runs through steps until subroutine reaches Jump-to-cue step. Automatically starts another cue not included in the subroutine. You can jump to any type of cue: regular, subroutine or effect.

Hold for Go

Runs through steps until hold for go step. Subroutine pauses until you press [Go].

Creating subroutines

Each subroutine can hold up to 24 steps. Each step lists a cue or a style. The jump-to-cue option essentially lets you increase the number of steps indefinitely until you exceed 400 cues total.

To create a subroutine follow these steps:

1. Create the cues you want to use in your subroutine.
2. Press [Blind]. You must be in Blind mode to create subroutines.
3. Press [Cue], and enter the cue number you want to assign to the subroutine.

Note: You cannot use effects cues in a subroutine except in jump-to-cue steps. If you include an effects cue in a jump-to-cue step, the cue in the previous step remains on stage while the effect plays. It remains on stage until a non-effect cue begins.

4. Press [Type] to display the fade type menu.
5. Select 4, **Subroutine**. Expression displays the screen illustrated below.

GRAND MASTER 100%												BLIND		STEP 1																	
NOT RECORDED																															
CUE 200												SUBROUTINE																			
*																															
A FADER				B FADER				C FADER				D FADER		CUE/TYPE		UP/DOWN		WAIT		LINK		DELAY									
CLEAR				CLEAR								31		00:05																	
1		2		3		4		5		6		7		8		9		10		11		12		SUBMSTR							
																								44		00:05					
																								44		00:00					
																								48		00:00		48.1		00:00	
13		14		15		16		17		18		19		20		21		22		23		24		PAGE 1		48.1		00:03			
																								LOADED		90		00:05			
SELECT STEP NUMBERS																															

6. Press [Cue Select]. The following line appears at the top of the screen.

CUE CROSSFADE TO 100% UP 00:00 DOWN 00:00 DELAY 00:00
7. Enter cue number you want for step one and press [Enter]. Cursor moves to Upfade field.
8. Enter an upfade time from .1 seconds to 99:59 minutes, then press [Enter]. Cursor moves to downfade field.
9. Enter downfade time from .1 seconds to 99:59 minutes, then press [Enter].
10. Enter delay time from .1 seconds to 99:59 minutes, then press [Enter]. Delay time is the time between the start of one cue and the start of the next.
11. Repeat steps 6 through 10 to add cues as subroutine steps.
12. Press [Style] to select a subroutine style. Styles are defined below.

When subroutine runs, *Expression* plays back each step in the sequence, as you have programmed up, down and delay times. When the subroutine reaches a style step, the style you select instructs the subroutine which step to play back next.

1 - **Loop**. Runs through preceding cues and then returns to first cue. Enter the number of times you want the loop to return to the top of the cue list. If you enter 5, the sequence will play 6 times. Enter 0 for a continuous loop.

2 - **Bounce**. Runs though preceding cues then plays them in reverse order. One bounce equals running through the sequence forward once and reverse once. Enter 0 for a continuous bounce.

3 - **Jump-to-cue**. Links subroutine to another cue or subroutine. Enter the number of the cue to link to.

4 - **Hold for Go**. Forces subroutine to pause until [Go] is pressed.

13. Complete entering all cue steps and style steps as described above and using the following editing keys:

[Step/Part]	Selects steps numbers. Selected steps are highlighted on a monochrome monitor or displayed in yellow on a color monitor.
[Cue Select]	Allows you to enter a cue number for the selected step.
[Style]	Displays the style menu.
[Type]	Allows you to select from the following fade types: <ul style="list-style-type: none"> Crossfade All increasing levels fade during upfade time; all decreasing levels fade during downfade time. Allfade All channels fade to black. Plusfade Increasing levels fade during upfade time, adding to current look; no channels downfade.
Arrow keys	Use the arrow keys to move from one field or line to the next. For example, press arrow down to select the next step, or press right arrow to enter information one field to the right of the current field.
[And]	Selects steps.
[Thru]	Selects steps.
[At]	Sets intensity level.
[Full]	Sets level at full.
[Time]	Sets upfade, downfade and delay times.
[Rec]	Records the subroutine as a cue.

14. Press [Rec], enter cue number, and press [Enter] to record subroutine cue.

Deleting a step

Press [Step/Part], and enter the step number. Then press [Clear]. *Expression* deletes the selected step and renumbers the remaining steps.

Inserting a step

Press [Step/Part], and enter the step number where you want to insert the new step. Press [Step/Part] again. *Expression* inserts a blank step before the selected step.

Subroutine keystrokes:

Key	Action
[Blind]	Displays Blind mode screen.
[Cue]	Selects cue number.
[7]	Enters cue number.
[Type]	Displays fade type menu.
[4]	Select subroutine fade type.
[Cue Select]	Indicates next number entered will be cue number.
[1] [Enter]	Enters cue 1.
[3] [Enter]	Enters 3 second upfade.
[Enter]	Accepts 3 second downfade.
[5] [Enter]	Enters 5 second delay time before second cue begins.
[Cue Select]	Indicates next number entered will be cue number.
[2] [Enter]	Enters cue 2.
[At] [7][5]	Enters 75 percent intensity level for cue.
[1] [Enter]	Enters 1 second upfade time.
[4] [Enter]	Enters 4 second downfade time.
[1][0] [Enter]	Enters 10 second delay time.
[Cue Select]	Indicates next number entered will be cue number.
[3] [Enter]	Enters cue 3.
[At] [5][0]	Enters 50 percent intensity level for cue.
[5] [Enter]	Enters 5 second upfade time.

[Enter]	Accepts 5 second downfade time.
[Enter]	Accepts 00 second delay time.
[Enter]	Displays style menu.
[1]	Selects loop.
[2]	Indicates to return to start of loop twice. Subroutine makes three runs through steps.
[Enter]	Enters the style.
[Record]	Records subroutine cue.
[Enter]	

Lesson 7

Working with autoloads

The autoload feature lets you load and playback cues in both fader pairs simultaneously. You can record any type of cue in an autoload. For example, you might want to run a regular crossfade cue in one fader and an effects cue in the other.

Autoloads also let you playback the same effects cue at different rates during different times in the show.

Expression lets you store up to 25 autoloads; they are not cues and are not included in the 400 cue limit.

To record an autoload from Stage, you will first load and playback a cue or effect in each fader set. Then you can make manual adjustments to playback rates or intensity levels for linked cues or effects, if necessary. When you save the autoload, *Expression* records any manual adjustments you have made.

Recording autoloads from Stage

To record an autoload from Stage follow these steps:

1. Press [Stage].
2. Press [Cue], and enter one of the cue numbers you want to record in the autoload.
3. Press the AB fader [Go] to start the first cue.
4. Press [Cue], and enter the second cue you want to record in the autoload.
5. Press the CD fader [Go] to start the second cue.
6. Make any rate and intensity adjustments necessary to linked cues or effects while they are running. For linked cues and effects, faders A and C control intensity levels; faders B and D control playback rates. See page 5 - 44 for more information on taking manual control of autoloads.

When you include crossfade or allfade cues, you cannot adjust their fade times.

7. Press [Rec].
8. Press [Autoload] and enter a number between one and 25.
9. Press [Enter] to record autoload.

Note: If you record an autoload with an effect or a cue in only one fader, the other fader pair is unaffected when you playback the autoload. This allows you to record the same effect in a number of autoloads with different rates, and use the second fader pair to run any cues you want.

For example, you may want to run the same effect at different rates on the cyc throughout a show. You can use the second fader pair to run other cues at the same time.

Recording, previewing and modifying autoloads from Blind

To record autoloads from the Blind mode screen, follow these steps:

1. Press [Blind] and [Autoload]. *Expression* displays the screen illustrated below.

GRAND MASTER 100% NOT RECORDED												BLIND				AUTO-LOAD 1				
AUTO LOAD SETUP INFORMATION												CUE INFORMATION (MUST BE EDITED IN CUE)								
*AUTO-LOAD 01: A-B CUE C-D CUE																				
AUTO-LOAD 02: A-B CUE C-D CUE																				
AUTO-LOAD 03: A-B CUE C-D CUE																				
AL 04: A-B												/C-D								
A FADER				B FADER				C FADER				D FADER				CUE/TYPE	UP/DOWN	WAIT	LINK	DELAY
CLEAR				CLEAR				SUBMSTR				LEVEL	48	00:00	48.1	00:03	00:05	48.1	00:00	
1	2	3	4	5	6	7	8	9	10	11	12	PAGE 1	48.1	00:03	00:05	48.1	00:00			
13	14	15	16	17	18	19	20	21	22	23	24	LOADED	90	00:05						
SELECT AUTO-LOAD NUMBER																				

2. Enter autoload number you want to create or modify, and press [Enter].
3. Enter cue number you want to play from AB fader, and press [Enter].
4. For effects and linked cues, you can modify level settings and playback rates in an autoload. To enter a percentage of the recorded level, press [At] and enter a two-digit level. To playback a cue at full recorded level, press [Full].

Note: When you play an effect in autoload, the level and rate settings will be applied to channels on stage from the previously run cue.

5. To modify playback rate, press [Time]. Enter a number between zero and 100 to indicate playback rate: zero stops the sequence, 50 plays it back at the recorded rate, and 100 flashes through cues or steps instantaneously.
6. Enter cue number you want to play from CD fader, and press [Enter].
7. Repeat steps four and five, if necessary, for second cue.

Playing back autoloads

To playback autoloads, press [Autoload], and enter number of the autoload you want to playback. Then press either [Go] key.

When you playback autoloads, the left fader in each fader pair controls intensity levels. The right fader controls the playback rate. When you begin an autoload with the right fader at **10**, *Expression* plays it back at the recorded rate; the LED strip indicates 50 percent on the right fader. To take manual control of the playback rate, move the fader to 50 percent. Then move the fader up or down to adjust rate; **10** is instantaneous playback through steps or cues, and **0** stops playback.

If right fader is set at any position other than **10** when you start the autoload, the linked cues or effects playback at the rate set on the fader.

Lesson 8

Working with macros

A macro works like a redial button on a telephone. You can store a series of keystrokes and later replay it with a simple keystroke. Macros simplify complex tasks that you perform often. You can program up to 125 macros in *Expression*. If you have expanded memory, you can program up to 640 macros.

For example, you might program a macro to simplify the process of performing a channel check. Rather than manually selecting each channel and bringing it up, and then clearing it and moving to the next channel, you can write a macro to do all the key punching for you.

You can include any keys on the console (except [Enter Macro], [Flash] and MIDI commands) in a macro. You cannot enter fader wheel movement. Each macro can contain up to 32 keystrokes. If you need more than 32 keystrokes, you can link macros together by putting a macro keystroke at the end of a macro to link it to another macro.

You can also program the macro to pause for any length of time between one second and one hour. The [Macro wait] key lets you program a pause anywhere in a macro.

Hint: See page 5 - 52 of this chapter for examples of some handy macros.

Creating or modifying a macro

Follow these steps to create a macro:

1. Plan your macro by determining exactly what keystrokes you want to include. You might want to do this by running through the task and writing down each keystroke.
2. Press [Set Up].
3. Select 13, **Edit macro buttons**, and press [Enter]. *Expression* displays the following screen.

EDIT MACRO BUTTONS		MACRO 1
MACRO	OPERATION(S)	
* 1		
2		
3		
4		
5		
6		
7		
8		
9		
10		
11		
12		
13		
14		

SELECT MACRO NUMBER, THEN PRESS "ENTER"

4. Press the number of the macro you want to create, then press [Enter].
5. Enter keystroke sequence by pressing desired keys.
6. Use the arrow keys as described below to edit macro, if necessary.

Left and right arrows

Moves highlight to left or right.

Up arrow

Inserts keystroke before highlighted keystroke.

Down arrow

Deletes highlighted keystroke.

Macro wait

To program a pause in the macro, press [Macro wait]. *Expression* displays **Macro-wait 00:00**. You can enter time either in minutes and seconds or as a fraction of a second in decimal format. For example, all of the following are acceptable: .2, 00:12, 5.5, 5:30.

7. Press [Enter Macro] to save the macro.
8. Press another macro number, and press [Enter] to create or edit another macro. Or, press another mode key to exit macro screen.

Hint: If you exceed the 32 command limit, link another macro to the end by entering another macro number as the last command, and finish entering commands in the linked macro.

Using submasters in macros

You can enter a submaster bump switch in a macro to function in three different ways: to act as a normal bump switch; to fade a submaster to full, regardless of its current condition; or to fade a submaster out, regardless of its current condition. The last two options are most useful for submasters with a long or infinite wait time.

To enter a bump switch that functions normally, that is, starts a timed submaster or changes the direction of a running fade, just press the bump switch. *Expression* enters the message **SUBN**, where *N* is the submaster number.

To enter a bump switch that fades the submaster to full, press and hold the bump switch, and press [Enter]. *Expression* enters the message **ON-SUBN**, where *N* is the submaster number.

To enter a bump switch that fades out submaster, press and hold the bump switch, and press [Clear]. *Expression* enters the message **CLEAR-SUBN**, where *N* is the submaster number.

Running a macro

To run macros one through five, press the appropriate blue macro key. For example, to run macro one, press [M1].

To run macros six and beyond, press [M*], the number of the macro, and [Enter]. For example, to run macro 10, press [M*], [1][0], [Enter].

Putting a macro on hold

You can put a running macro on hold by pressing [Macro wait]. To release the macro from hold, press the macro button again (or M* and the macro number for macros 6 and beyond).

Canceling a macro

To cancel a running macro, press the macro key again, or press [Macro wait] twice.

Deleting a macro

To delete a macro follow these steps:

1. Press [Setup].
2. Select 11, **Clear macro buttons**, and press [Enter].
3. To clear a range of macros, enter the first macro number you want to clear, and press [Enter]. Then enter the last macro number you want to clear, and press [Enter].

To clear all macros, press [0].

4. Press [Enter] to complete the command, or press [Clear] to cancel it.

Sample macros

Channel check

At 00 + Full

This macro brings each channel up to full for a channel check. Before you begin, you'll probably want to bring up at least one channel for working light, then clear all other channels from stage. Press [Stage] and start macro. Press macro key again to check each subsequent channel.

Auto channel check

At 00 + Full Macro-Wait 00:02 Mn (n = macro number)

This macro automatically runs through each channel with a two second wait in between each channel. To pause the automatic check, press [Macro Wait]. To resume macro, press macro key again.

Turn off all lights except work lights

Chan 1 Thru - At 00 Chan n Full (n=work lights channel)

This macro captures all channels and sets them to zero. This overrides all faders and submasters. Then the macro sets work lights at full. You can easily return to previous settings by pressing Rel to release captured channels.

Clear faders and turn work lights on

Clear-AB Clear-CD Chan n Full (n=work lights channel)

chapter 6

using print and disk options

This chapter includes instructions for using *Expression's* print and disk options. Each of the following reports is explained and illustrated on the following pages.

- Cues
- Cue sheet
- Designer's Worksheet
- Groups
- Group Sheet
- Macro buttons
- Real time programs
- Softpatch
- Stage display
- Submasters
- Submaster Sheet
- Track Sheet

Expression is equipped with a 3.5-inch disk drive on the right side panel of the console. It allows you to save backup copies of shows on disk. Disk options and disk management are discussed in the section titled *Disk management* on page 6 - 15. The following options are described:

- Format disk
- Record show on disk
- Read show from disk
- Verify show on disk
- Erase show from disk

Print options

Before you begin printing, verify that your printer is installed correctly and that it is turned on. For instructions on installing printers, see *Chapter 2, Installation*. Fades in progress pause when reports are printing.

All print options are located on the Print Functions menu. To display the menu press [Set Up], select option 7, **Print Functions**, and press [Enter]. *Expression* displays the Print Functions screen illustrated below.

GRAND MASTER 100%		PRINT FUNCTIONS	MENU 9
SELECT	FUNCTION		
1	PRINT STAGE DISPLAY		
2	PRINT CUES		
3	PRINT GROUPS		
4	PRINT SUBMASTERS		
5	PRINT TRACK SHEET		
6	PRINT SOFTPATCH		
7	PRINT CUE SHEET		
8	PRINT REAL TIME PROGRAMS		
* 9	PRINT DESIGNER'S WORKSPACE		
10	PRINT MACRO BUTTONS		

SELECT FUNCTION NUMBER, THEN PRESS "ENTER"
(PRESS "CLEAR" TO RETURN TO SETUP MENU)

To print a report:

1. Enter menu option number, and press [Enter].
2. Follow prompts that ask for beginning and ending numbers, if any.
3. Press [Enter]. *Expression* sends reports to the printer.

To cancel the print operation before *Expression* sends the report to the printer, press [Clear]. To stop printer while it is printing, press [Set Up].

Cues

The cue report prints each cue on a separate page. From the Print Options Menu, select 2, and press [Enter]. Enter the first cue number you want to print, or enter 0 if you want to print all recorded cues. Press [Enter]. If you are selecting a range of cues to print, *Expression* prompts you for the last cue number to print. Enter the last cue number you want, and press [Enter]. *Expression* sends the report to the printer.

To cancel the print operation before *Expression* sends the report to the printer, press [Clear].

```

EXPRESSION LIGHTING CONTROL SYSTEM          ELECTRONIC THEATRE CONTROLS, INC.
CUE   1.1 XFAD 00:07/00:07 WT 00:00 LK   1.2 DL 00:07

  1  2  3  4  5  6  7  8  9 10 11 12  13 14 15 16 17 18 19 20 21 22 23 24
FF FF FF FF FF 75 75 75 75 75          21 21 21 21 21 21 21 21 21 21 21
25 26 27 28 29 30 31 32 33 34 35 36  37 38 39 40 41 42 43 44 45 46 47 48
21 21 21 21 21 21 21 21 21 21 21 21  21 21 21 21 21 21 21 21 21 21 21
49 50 51 52 53 54 55 56 57 58 59 60  61 62 63 64 65 66 67 68 69 70 71 72
21 21 21 21 21 21 21 21          21 21 21 21 21 21 21 21 21 21 21 21
73 74 75 76 77 78 79 80 81 82 83 84  85 86 87 88 89 90 91 92 93 94 95 96

97 98 99 10  1  2  3  4  5  6  7  8

```

Cue sheet

The cue sheet report lists all recorded cues. From the Print Options Menu, select 7, and press [Enter]. Enter the first cue number you want to print, or enter 0 if you want to print the entire cue sheet. Press [Enter]. If you are selecting a range of cues to print, *Expression* prompts you for the last cue number to print. Enter the last cue number you want, and press [Enter]. *Expression* sends the report to the printer.

To cancel the print operation before *Expression* sends the report to the printer, press [Clear].

EXPRESSION LIGHTING CONTROL SYSTEM				ELECTRONIC THEATRE CONTROLS, INC.			
CUE SHEET							
CUE	1.1	XFAD	00:07/00:07	WT	00:00	LK	1.2 DL 00:07
CUE	1.2	XFAD	00:07/00:07	WT	00:00	LK	6 DL 00:07
CUE	6	XFAD	00:00/00:00	WT	00:00	LK	6.1 DL 00:00
CUE	6.1	XFAD	00:03/00:03	WT	00:00	LK	6.2 DL 00:03
CUE	6.2	XFAD	00:03/00:03	WT	00:00	LK	6.3 DL 00:03
CUE	6.3	XFAD	00:05/00:05	WT	00:00	LK	7 DL 00:05
CUE	7	XFAD	00:20/00:20	WT	00:00	LK	8 DL 00:20
CUE	8	XFAD	00:10/00:10	WT	00:00	LK	10 DL 00:10
CUE	10	XFAD	00:03/00:03	WT	00:00	LK	11 DL 00:03
CUE	11	XFAD	00:05/00:05	WT	00:00	LK	12 DL 00:05
CUE	12	XFAD	00:03/00:03	WT	00:00	LK	13 DL 00:03
CUE	13	XFAD	00:05/00:05	WT	00:00	LK	14 DL 00:05
CUE	14	XFAD	00:03/00:03	WT	00:00	LK	14.1 DL 00:03
CUE	14.1	XFAD	00:05/00:05	WT	00:00	LK	15 DL 00:05
CUE	15	XFAD	00:07/00:07	WT	00:00	LK	15.5 DL 00:07
CUE	15.5	XFAD	00:10/00:10	WT	00:00	LK	16 DL 00:10
CUE	16	XFAD	00:03/00:03	WT	00:00	LK	17 DL 00:03
CUE	17	XFAD	00:05/00:05	WT	00:00	LK	18 DL 00:05
CUE	18	XFAD	00:02/00:03	WT	00:00	LK	19 DL 00:03
CUE	19	XFAD	00:10/00:10	WT	00:00	LK	20 DL 00:10
CUE	20	XFAD	00:10/00:10	WT	00:00	LK	21 DL 00:10
CUE	21	XFAD	00:10/00:10	WT	00:00	LK	22 DL 00:10

Designer's Worksheet

Since Worksheet regions are specialized macros, when you select the Print Designer's Worksheet option, *Expression* prints all macros and worksheet regions.

From the Print Options Menu, select 9, and press [Enter]. Enter the first region you want to print, or enter 0 if you want to print all regions. Press [Enter]. If you are selecting a range of regions to print, enter the last region you want, and press [Enter]. *Expression* sends the report to printer.

To cancel the print operation, press [Clear].

```
EXPRESSION LIGHTING CONTROL SYSTEM          ELECTRONIC THEATRE CONTROLS, INC.

REGION OPERATION(S)

CHAN 1 THRU 25 AT 55

REC SUB -

SETUP 1 ENTER 1 ENTER 1 ENTER 2 ENTER

STAGE CUE 500 GO-AB

CHAN 1 THRU - AT 00
```

Group Sheet

Group Sheet is a feature of *Expression's* expanded memory option. *Expression* will only the print group sheet report when the expanded memory option is installed.

The group sheet report lists all recorded groups. If you have named the groups using the optional alphanumeric keyboard, the group name is also included in the printout.

To print group sheet, select 11 from the Print Options menu, then press [Enter].

EXPRESSION LIGHTING CONTROL SYSTEM	ELECTRONIC THEATRE CONTROLS, INC.
GROUP SHEET	
<hr/>	
1 BLUE CYC	
2 RED CYS	
3 BLUE BACKS	
4 PINK FRONTS	
5 AMBER DOWN LIGHTS	

Macros

The macro buttons report lists all recorded macros. It also prints Designer's Worksheet regions since they are specialized macros.

From the Print Options Menu, select 10, and press [Enter]. Enter the first macro you want to print, or enter 0 if you want to print all macros. Press [Enter]. If you are selecting a range of macros to print, *Expression* prompts you for the last macro. Enter the last macro you want, and press [Enter]. *Expression* sends the report to the printer.

To cancel the print operation, press [Clear].

```
EXPRESSION LIGHTING CONTROL SYSTEM          ELECTRONIC THEATRE CONTROLS, INC.

MACRO OPERATION(S)
-----
1  CHAN 1 THRU - AT FULL
2  AT 00 + FULL M2
3  SETUP 6 ENTER 6 ENTER
```

Real time programs

From the Print Options Menu, select 8, and press [Enter]. *Expression* prints a report of all recorded real time programs on one sheet.

EXPRESSION LIGHTING CONTROL SYSTEM		ELECTRONIC THEATRE			
CONTROLS, INC.					
CLOCK					
PROGRAM :	START CUE	TIME ON	TIME OFF	DAYS OF WEEK	
:					
1 :	1	14:52	16:32	SU MN TU	TR
:					
2 :	15	00:25	01:03	SU TU	TR SA
:					
3 :	2	18:36	18:40		TR FR SA
:					

Softpatch

The softpatch report lists current dimmer-to-channel patches. When you select the Print Softpatch option *Expression* sends the report to the printer immediately. No options are available for this report. From the Print Options Menu, select 6, and press [Enter].

EXPRESSION LIGHTING CONTROL SYSTEM		ELECTRONIC THEATRE CONTROLS, INC.	
SOFTPATCH			
CHN: DIMMER / LEVEL% / PROFILE			
:			
01:	110	136	
:	55/6	88/4	
:			
02:	109	137	
:	60/6	60/6	
:			
03:	121	122	144
:	60/6	60/6	60/6
:			
04:	120	145	
:	/8	/8	
:			
05:	117	128	
:			
:			
06:	142	152	
:			
:			
07:	56		
:			

Submasters

The submaster report prints each submaster on a separate page. From the Print Options Menu, select 4, and press [Enter]. Enter the first submaster number you want to print, or enter 0 if you want to print all recorded submasters. Press [Enter]. If you are selecting a range of submasters to print, *Expression* prompts you for the last submaster number you want. Enter the last number, and press [Enter]. *Expression* sends the report to the printer.

To cancel the print operation before *Expression* sends the report to the printer, press [Clear].

EXPRESSION LIGHTING CONTROL SYSTEM												ELECTRONIC THEATRE CONTROLS, INC.												
SUBMASTER	53	UP	00:00	WT	MAN	DN	00:00	PILE-ON																
1	2	3	4	5	6	7	8	9	10	11	12	13	14	15	16	17	18	19	20	21	22	23	24	
FF	FF	FF	FF	FF	11		03	03	17	17	17	34		07										
25	26	27	28	29	30	31	32	33	34	35	36	37	38	39	40	41	42	43	44	45	46	47	48	
11	11					11	11	11	34	34	10	20	20	10	10	10	28							
49	50	51	52	53	54	55	56	57	58	59	60	61	62	63	64	65	66	67	68	69	70	71	72	
					17	07	34				11	11	11	11	34	34	34	34						
73	74	75	76	77	78	79	80	81	82	83	84	85	86	87	88	89	90	91	92	93	94	95	96	
97	98	99	10	1	2	3	4	5	6	7	8													

Submaster Sheet

Submaster Sheet is a feature of *Expression's* expanded memory option. *Expression* will only print the submaster sheet report if the expanded memory option is installed.

The submaster sheet report prints all 48 submasters (24 in each of two pages). If recorded, upfade, wait and downfade times are included in the printout. In addition, if you have named the submasters using the optional alphanumeric keyboard, the submaster name is also included in the printout.

To print submaster sheet, select 12 from the Print Options menu, then press [Enter].

EXPRESSION LIGHTING CONTROL SYSTEM		ELECTRONIC THEATRE CONTROLS, INC.		
SUBMASTER SHEET				
SUBMASTER	UP	WAIT	DOWN	
01	00.0	00.0	00.0	
02	00.0	00.0	00.0	
03	00.0	00.0	00.0	
04	00.0	00.0	00.0	
05	00.0	00.0	00.0	
06	00.0	00.0	00.0	
07	00.0	00.0	00.0	
08	00.0	00.0	00.0	
09	00.0	00.0	00.0	
10	00.0	00.0	00.0	
11	00.0	00.0	00.0	
12	00.0	00.0	00.0	
13	00.0	00.0	00.0	
14	00.0	00.0	00.0	
15	00.0	00.0	00.0	
16	00.0	00.0	00.0	
17	00.0	00.0	00.0	
18	00.0	00.0	00.0	
19	00.0	00.0	00.0	
20	00.0	00.0	00.0	
21	00.0	00.0	00.0	
22	00.0	00.0	00.0	
23	00.0	00.0	00.0	
24	00.0	00.0	00.0	

Track Sheet

The Track Sheet report lists all level settings for a specific channel in all recorded cues. From the Print Options Menu, select 5, and press [Enter]. Enter desired channel number, and press [Enter]. *Expression* sends report to the printer.

To cancel the print operation before *Expression* sends the report to the printer, press [Clear].

EXPRESSION LIGHTING CONTROL SYSTEM CONTROLS, INC.					ELECTRONIC THEATRE				
TRACKSHEET FOR CHANNEL 06					CUE 1.1 TO 600				
1.1	1.2	6	6.1	6.2	6.3	7	8	10	11
75	00	00	00	00	00	00	FF	00	50
12	13	14	14.1	15	15.5	16	17	18	19
00	FF	50	FF	00	00	00	00	FF	50
20	21	22	23	23.1	24	24.5	25	26	27
50	50	50	50	50	FF	00	00	00	00
28	29	30	31	32	32.5	32.6	33	33.3	33.5
00	FF	FF	50	50	50	50	FF	FF	00
34	34.5	35	36	37	38	39	40	41	41.1
00	00	00	68	50	50	FF	FF	00	00
41.2	41.5	42	100	500	500.1	500.2	500.3	500.4	500.5
00	FF	FF	00	00	00	00	00	FF	FF
500.6	500.7	520	520.1	520.2	520.3	600			
00	00	00	00	FF	FF	00			

Disk management

Expression's disk drive lets you save up to two shows per standard 3.5-inch computer disk. * This allows you to work on more than one show at a time or to use more than 400 cues for your production by loading a second show into memory after the first 400 cues.

** If you have installed expanded memory, only one show may be saved per disk.*

We recommend that you make two back-up copies of each show on separate disks and that you keep them in different locations. If your show disk were damaged, a back-up disk stored at home could save you hours of work.

When you select disk options, any fades in progress are stopped. Therefore, if you need to load an additional show in the middle of a performance, load it between cues when all channels are static. Disk options do not affect channel levels that are not currently fading.

Before you can use a disk in *Expression*, you must format it on the console. Formatting instructions are on the following page.

Note: If you read a show that you saved from an Insight console, Expression will not read the submasters from the disk. Likewise, if you record a show on Expression and read it in an Insight console, you will not be able to read submasters.

Storing disks

Computer disks are somewhat fragile, magnetic devices for storing your work. Therefore, we suggest the following disk storage and handling practices to ensure that your work is not lost as a result of disk damage.

- Store disks at a temperature between 50 and 140 degrees Fahrenheit.
- Keep disks away from magnets, magnetized objects or heavy electrical equipment. Some large lighting equipment may damage disks.
- Do not touch the magnetic disk inside the plastic disk case.
- Do not eat, drink or smoke when you handle disks.

Formatting disks

Before you can use a disk in an *Expression*, you must format it *on an ETC console*. Disks formatted on a standard personal computer do not work in *Expression*. To format a disk, follow these steps:

Warning: Formatting a disk erases all information recorded on it. Formatting does not affect show in console.

1. Press [Set Up].
2. Insert standard 3.5-inch, double-density, double-sided disk in disk drive.
3. Select 5, **Format Disk**, and press [Enter].
4. To format the disk, press [Enter]. To cancel the format command, press [Clear].

Warning: When you select this option, any fades in progress stop; you cannot restart them except by reselecting cues from Stage and pressing [Go] again.

Recording a show on disk

We recommend that you keep at least one backup copy of each show on a disk. Keep disks in a dry, safe place.

When using the record option, any fades being executed are interrupted during the record operation; fades resumes when record is complete. To record a show from memory to a disk follow these steps:

1. Insert a formatted disk in disk drive.
2. Press [Set Up].
3. Select 1, **Record show on disk**, and press [Enter]. *Expression* displays the screen illustrated below:

```

      TO RECORD ONTO DISK, SELECT SHOW NUMBER, THEN PRESS "ENTER"
      TO ABORT, PRESS "CLEAR"

      SHOW 1:          RECORDED
      SHOW 2:          RECORDED

      <USE DOUBLE SIDED, DOUBLE DENSITY DISK ONLY>

```

If either show is currently recorded on disk, the screen displays the message, **Recorded**, or the date recorded if you have the Real Time Clock option. If no show is recorded on disk, *Expression* displays the message, **Not recorded**.

4. Select either show one or two and press [Enter]. If the show number you select is already recorded, the new show will overwrite the old show.

Or, press [Clear] to cancel the operation.

Note: We recommend that you verify the show immediately after recording it to ensure that it was recorded with errors. See page 6 - 19 for instructions.

Reading a show from disk

When you read a show from a disk and load it into memory, the new show overwrites the current show in the board. Therefore, if you want to keep the current show, follow the instructions on the previous page to record current show before you read a new show from disk.

When using the read option, any fades being executed are interrupted during the read operation; fades resume when read is complete. To read a show from disk into memory follow these steps:

1. Insert disk in disk drive.
2. Press [Set Up].
3. Select 2, **Read show from disk**, and press [Enter]. *Expression* displays the screen illustrated below:

```

TO READ FROM DISK, SELECT SHOW NUMBER, THEN PRESS "ENTER"
TO ABORT, PRESS "CLEAR"

SHOW 1:      RECORDED
SHOW 2:      RECORDED

<USE DOUBLE SIDED, DOUBLE DENSITY DISK ONLY>
```

If either show one or two is currently recorded on disk, the screen displays the message, **Recorded**, or the date recorded if you have the Real Time Clock option. If no show is recorded on disk, *Expression* displays the message, **Not recorded**.

4. Select either show one or two, and press [Enter]. The show you enter will overwrite the current show in memory.

Or, press [Clear] to cancel the operation.

Note: See page 4 - 38 for information about submaster pages when reading a new show into console.

We recommend that you verify the show immediately after reading it to ensure that it was read without errors. See page 6 - 19 for instructions.

Verify show on disk

The **Verify show on disk** option compares a show that is recorded on disk with the show in memory. *Expression* indicates if the shows are identical or not.

You may want to use this option to verify that your disk is not damaged and that your show was copied to disk without any errors. You might also use it to compare backup copies of a show with the current version in memory.

When using the verify option, any fades being executed are interrupted; fades resume when read is complete. To compare a show recorded on disk with the show in memory, follow these steps:

1. Insert disk in disk drive.
2. Press [Set Up].
3. Select 3, **Verify show on disk**, and press [Enter]. *Expression* displays the screen illustrated below:

```
TO VERIFY DISK, SELECT SHOW NUMBER, THEN PRESS "ENTER"  
TO ABORT, PRESS "CLEAR"  
  
SHOW 1:      RECORDED  
SHOW 2:      RECORDED  
  
(USE DOUBLE SIDED, DOUBLE DENSITY DISK ONLY)
```

If either show one or two is currently recorded on disk, the screen displays the message, **Recorded**, or the date recorded if you have the Real Time Clock option. If no show is recorded on disk, *Expression* displays the message, **Not recorded**.

4. Select either show one or two and press [Enter]. *Expression* compares the show you selected from disk with the show in memory.

If show on disk matches show in memory, *Expression* displays the message, **Show on disk matches system memory**.

If you receive the **Verify failed** message, you may have any of the following problems:

- Show on disk is not the same as show in memory.
- Disk is damaged.
- Console did not record show to disk correctly.

Retry recording or reading show if you receive this message. If it recurs, try a new disk.

The message **Configurations differ, cannot verify** indicates one the following:

- Show on disk was saved on a different type of ETC console or a different software version.
- Show on disk has different system settings (such as softpatch, numbers of dimmers and channels) than show in console.

Erase show from disk

If you want to erase a show from a disk, use the Erase show from disk option. Once a show is erased from a disk you cannot retrieve it.

When using the erase option, any fades being executed are interrupted; fades resume when erase is complete. To erase a show from disk, follow these steps:

1. Insert disk in disk drive.
2. Press [Set Up].
3. Select 4, **Erase show on disk**, and press [Enter].
4. Select either show one or two and press [Enter]. Or, press [0] and [Enter] to erase both shows.

chapter 7

accessories

This chapter includes instructions for working with the following *Expression* optional accessories:

- Alphanumeric keyboard
- Designer's Worksheet
- Infrared Remote Focus Unit (IRFU)
- Remote Focus Unit (RFU)
- MIDI
- Real Time Clock
- Serial Button Protocol
- Redundant Tracking Backup
- Remote Submasters and Macros

For accessory installation instructions, see *Chapter 2, Installation*. For purchase information, please contact your local dealer or ETC.

Alphanumeric keyboard

The alphanumeric keyboard allows you to assign names to cues, sub-masters, groups and shows. It is available only when expanded memory is installed. Call ETC or your local dealer to add the expanded memory option to your console.

Once you have installed the expanded memory option, you can install a standard PC XT/AT compatible, manually switchable, alphanumeric keyboard. The keyboard can be used only in the XT-compatible mode. Although many keyboards can be used with the *Expression* control console, ETC recommends the Datacomp Electronics model DFK121A08 and Unitek K-155 keyboards.

Keyboards that have an *Auto* setting must be switched to *XT* mode. Automatic switching keyboards must be manually set when used with *Expression 2.0*.

Note: Console must be off when keyboard is plugged in. Refer to Chapter 2, Installation, for installation instructions.

Naming cues, submasters and groups

You can use the alphanumeric keyboard to assign names to cues, submasters and groups. Names can consist of letters, numbers or the symbols: **#, %, &, *, (,), +, ', -, [,], /** as well as the comma and period.

Follow these steps to name a cue or submaster:

1. Press [Stage], [Blind] or [Fader] to select a display mode.
2. Press [Cue], [Submaster] or [Group], then use the *Expression* number keys to select the desired look.
3. Press [F1] on the alphanumeric keyboard, and type the desired name. You can assign cues and groups names of up to 25 characters. Submaster names can have up to 10 characters. Group names can have up to 25 characters.

You may enter the name using overwrite or insert mode. In overwrite, you type over any previously entered characters; in insert mode, each new character pushes the previously entered characters one space to the right. Press [Insert] on the keyboard to toggle between insert and overwrite mode.

4. Press [F2] to delete all text in the naming window.
5. Press [Enter] on the alphanumeric keyboard to record the name, or press [Esc] to quit and return to the original *Expression* display screen.

Naming shows

You can use the alphanumeric keyboard to name the show currently loaded in the console. The names you give shows can consist of letters, numbers or the symbols: **#, %, &, *, (,), +, ', -, [,], /** as well as the comma and period. Follow these steps to name a show:

1. Press [Setup].
2. Press [F1] on the alphanumeric keyboard and enter the name you want to give the show. The show name can have up to 25 characters.

You may enter the name using overwrite or insert mode. In overwrite, you type over any previously entered characters; in insert mode, each new character pushes the previously entered characters one space to the right. Press [Insert] on the keyboard to toggle between insert and overwrite mode.

Press [F2] to delete all text in the naming window.

3. Press [Enter] on the alphanumeric keyboard to record the name, or press [Esc] to quit and return to Setup display.

Designer's Worksheet

Designer's Worksheet gives you control of the console from any remote location such as in the house, on the set, or backstage. The Designer's Worksheet is a digitizer tablet that emulates the console face panel in addition to providing user definable regions. All functions may be selected using a stylus.

Three digitizer templates are available. The correct template for your worksheet depends on your digitizer's size and your console's memory.

12 x 12 inch digitizer

If you own a 12 x 12 inch digitizer and do not have expanded memory, you can program up to 125 regions, and you can use the digitizer to control submasters and faders.

12 x 12 inch digitizer (with expanded memory)

If you own a 12 x 12 inch digitizer and have expanded memory, you can program up to 640 regions; and you can select one of two digitizer layouts. One layout provides control of submasters and faders, while the other deletes the submasters for increased workspace area.

17 x 12 inch digitizer tablet (requires expanded memory)

You must have expanded memory to use 17 x 12 inch digitizer. The larger digitizer allows you to program up to 640 regions; you cannot control submaster pots with the 17 x 12 inch digitizer.

If you have not yet installed your Designer's Worksheet, see *Chapter 2, Installation*. When your worksheet is installed and turned on, you should see the message **DWS On** on the screen.

Using the digitizer

To use the digitizer to control console keys, touch the corresponding *button* on the worksheet with the stylus. To use submaster pots or the fader wheel, drag the stylus along the corresponding control strip.

The remaining area of the tablet is available for user-definable regions. Within each of these regions you may assign a sequence of up to 32 console key presses. Each region is a special type of macro that you can use to execute cues, manipulate channel levels or execute any series of keystrokes. Once you have programmed a region, you can start the macro by touching the region on the tablet.

For example, you might draw a picture of the stage and outline regions corresponding to various instruments or fixtures on stage or in a studio. You might program each region to select the channels for that area of the stage. You can then touch that region to select channels, and then enter desired level.

Or, you might program more abstract regions on the worksheet. For example, you might program several areas on the worksheet, each representing a song in a band's play list.

Programming regions

Before you begin programming, design your worksheet regions by drawing them on the worksheet tablet provided. Place your drawing under the clear plastic cover sheet, and you're ready to start.

To create new or edit existing regions and macros, follow these steps:

1. Turn Designer's Worksheet on. You should see the message **DWS On** on the screen.
2. With the worksheet pen, touch [Set Up]. *Expression* displays the Set Up Menu.
3. Select 17, **Edit Designer's Worksheet**, and touch [Enter]. *Expression* displays the screen illustrated below.

EDIT DESIGNER'S WORKSPACE		REGION 1
REGION	OPERATION(S)	
* 1		
2		
3		
4		
5		
6		
7		
8		
9		
10		
11		
12		
13		
14		

SELECT REGION NUMBER OR TOUCH A PREVIOUSLY-DEFINED REGION,
THEN TOUCH "ENTER"

4. To create a new region, enter the number you want. Or select an existing region either by touching the region on the worksheet or by entering the number from the number pad.
5. Touch [Enter].

6. To create a new region or to change an existing region, trace the area you want to define for that macro number. To keep an existing region, touch [Enter].

Expression displays a highlighted **R** next to the macro number to indicate that a region is defined for it.

7. Touch desired keystrokes. As you touch keys on worksheet, they are displayed on the screen.
8. Use the arrow keys as described below to edit macros, if necessary.

Left and right arrows

Move highlight to left or right.

Up arrow

Inserts keystroke before highlighted keystroke.

Down arrow

Deletes highlighted keystroke.

Macro wait

To program a pause in the macro, press [Macro wait]. *Expression* displays **Macro-wait 00:00**. Enter the length of the pause in minutes and seconds, or as a fraction of a second in decimal form from .1 second to 99:59 minutes.

9. Touch [Enter Macro] to save the macro. Each macro has a 32 keystroke limit.
10. Enter another macro or edit an existing macro by following steps four through nine. Or, return to another mode by touching the appropriate key.

Hint: If you need to exceed the 32 command limit, link another region to the end by entering another region number as the last command, and finish entering commands in the linked macro.

Deleting regions

To delete a region, follow these steps:

1. Press [Setup] to display the Set Up Menu.
2. Select 12, **Designer's Workspace**, and press [Enter].
3. To clear a range of regions, enter the first region number you want to clear, and press [Enter]. Then enter the last region number you want to clear, and press [Enter].

To clear all regions, press [0].

4. Press [Enter] to complete the command, or press [Clear] to cancel it.

Infrared Remote Focus Unit (IRFU)

The Infrared Remote Focus Unit (IRFU) allows you to control the *Expression* console from distances up to 225 feet (75 yards). With it you can play back cues and macros, and access dimmers, channels, groups, and cues. The IRFU can also be wired to the main control console. To enable the IRFU in *Expression*, ETC must modify the console at the factory.

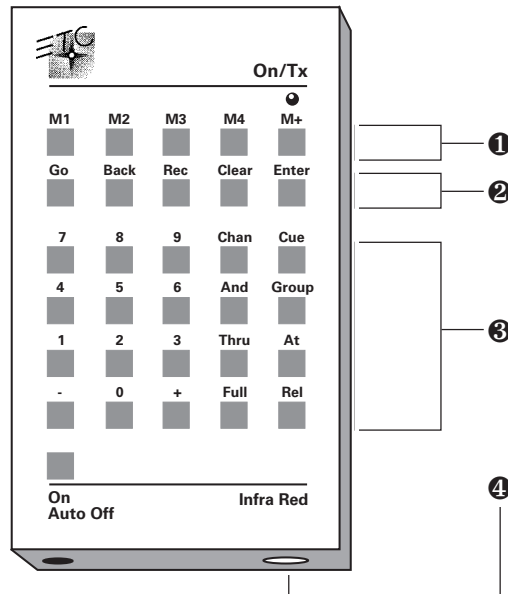

① Macro controls

The five macro keys allow you to access macros. M1, M2, M3, and M4 allow you to access macros one, two, three, and four. M* allows you to enter any other macro. To access other macros, press [M*], enter the desired macro number, and press [Enter].

② Fader controls

The fader control keys allow you to play back cues in the console's crossfaders. [Go] controls the AB fader pair; the remaining keys function as on the console keyboard.

③ Other controls

The remaining controls enable you to select dimmers, channels, groups, and cues. Keys function as they do on the console keyboard.

- ④ Connector for hard wire connection to receiving unit.

Pressing any key on the infrared controller automatically turns power on. Once you have turned the unit on, if no key is pressed after three minutes, the power shuts off. The unit is powered by a nine-volt, size PP3 battery.

Console controls and the infrared controller are able to operate simultaneously. Changes made from both console and infrared controller are displayed immediately on the console monitor.

Remote Focus Unit (RFU)

The Remote Focus Unit (RFU) is a small, portable control panel you can use from a remote location, such as in the house, on your studio set or from backstage. You can use an RFU with or without a remote monitor.

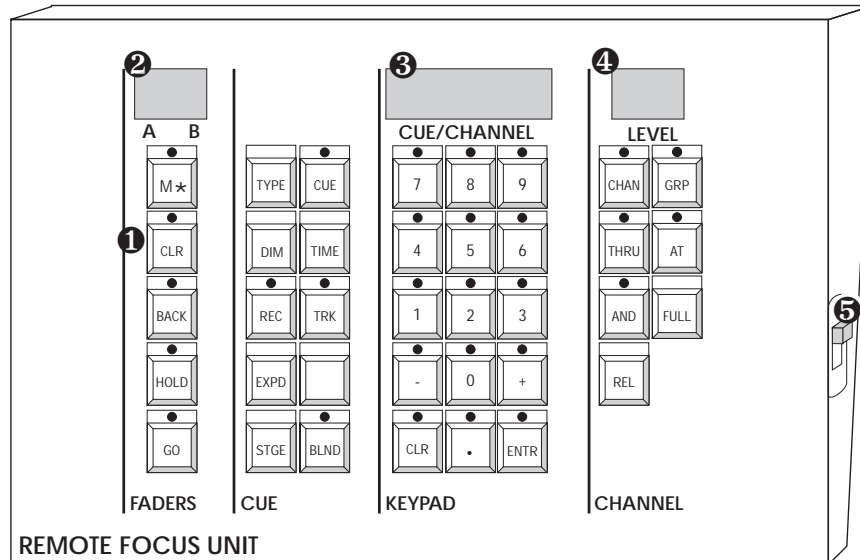

① Fader control keys

The fader control keys on the left side of RFU control the AB fader pair.

② Fader window

The fader window displays the percentage of the cue that has played.

③ Cue/channel number window

The cue/channel number window displays the currently selected cue or channel number.

④ Channel level window

The channel level window displays the level of currently selected channels.

⑤ Power switch

Power switch is on in the up position and off in the down position.

For RFU installation instructions see *Chapter 2, Installation*. RFU must be turned **Off** before you install it. For instruction on installing a remote monitor, see *Installing two monitors* on page 2 - 4.

To operate your installed RFU, move power switch to **On**. *Expression* displays the message, **RFU On** on the screen.

The console keypad and RFU are able to operate simultaneously. Changes made from both console and RFU are displayed immediately on both console monitor and RFU.

You can control the majority of console functions with RFU; you cannot control submasters, however.

Warning: Do not connect or disconnect the RFU when it is turned on.

MIDI

Expression supports MIDI (Musical Instrument Digital Interface). To enable MIDI in *Expression*, ETC must modify the hardware at the factory. Consoles configured with MIDI option will display a message indicating so during system boot.

Expression both transmits and receives MIDI messages with any MIDI instrument. The MIDI protocol can operate cues, macros and submaster bump switches.

ETC assumes that MIDI users have a working knowledge of MIDI. This section provides MIDI interface information, message formats and message definitions. If you need more technical information about MIDI, contact ETC.

Note: Macros cannot execute MIDI commands.

Interfacing with MIDI

Follow these steps to connect MIDI equipment to *Expression*:

1. Turn console power off.
2. Insert standard MIDI cable into the connector on the back of the console labeled **MIDI In**.

*Warning: Do not insert MIDI cable into connector labeled **Keyboard**; doing so may damage MIDI equipment.*

3. If you are sending MIDI commands from the console, insert another standard MIDI cable into the connector on the back of the console labeled **MIDI Out**.
4. Set DIP switch B7 **on** (up position). DIP switch B7 is located on the DIP switch panel label SWB on the back of the console.
5. Turn console on.
6. Press [Set Up] to display Set Up Menu. Then select 6, **System Settings**, and press [Enter] to display the System Settings Menu.
7. Select 5, **Select MIDI channel**, and press [Enter].

If MIDI option is not installed or if DIP switch is not correctly set, *Expression* displays the message, **Optional feature not installed on this system**.

8. Enter the MIDI channel you will use, and press [Enter]. Verify that your MIDI equipment is also set to the same channel. *Expression* will ignore MIDI commands on other channels.

Message formats

The following table lists MIDI message formats used to control *Expression*. All numbers are in Hex format.

Note off message format

<8n><kk><vv>

8 Note off status
n MIDI channel number (0-7)
kk Key number (0-7F)
vv Note off velocity (0-7F)

Note on message format

<9n><kk><vv>

9 Note on status
n MIDI channel number (0-7)
kk Key number (0-7F)
vv Note on velocity (0-7F)
[00=Note off]

Control change message format

<Bn><kk><vv>

B Control change status
n MIDI channel number (0-7)
kk Control number (0-79)
vv Control value (0-7F)

Program change message format

<Cn><kk>

C Program (patch) change status
n MIDI channel number (0-7F)
kk Program number (0-7F)

Message definitions

Submaster bump switch execution
 C5 - B5 Submasters 1 - 12
 C6 - B6 Submasters 13 - 24

Note: C5 = MIDI note #60 or middle C.

Cue execution in AB fader pair

Next cue Program change 0
 Cues 1 - 127 Program change 1 - 127
 Cues 128 - 255 Controller change 70, parameters 0 - 127
 Cues 256 - 383 Controller change 71, parameters 0 - 127
 Cues 384 - 511 Controller change 72, parameters 0 - 127
 Cues 512 - 639 Controller change 73, parameters 0 - 127
 Cues 640 - 767 Controller change 74, parameters 0 - 127
 Cues 768 - 895 Controller change 75, parameters 0 - 127
 Cues 896 - 999 Controller change 76, parameters 0 - 127

Cue execution in CD fader pair

Next cue Controller change 77, parameter 0
 Cues 1 - 127 Controller change 77, parameters 0 - 127
 Cues 128 - 255 Controller change 78, parameters 0 - 127
 Cues 256 - 383 Controller change 79, parameters 0 - 127
 Cues 384 - 511 Controller change 80, parameters 0 - 127
 Cues 512 - 639 Controller change 81, parameters 0 - 127
 Cues 640 - 767 Controller change 82, parameters 0 - 127
 Cues 768 - 895 Controller change 83, parameters 0 - 127
 Cues 896 - 999 Controller change 84, parameters 0 - 127

Macro execution

Macros 1 - 127 Controller change 85, parameters 0 - 127
 Macros 128 - 255 Controller change 86, parameters 0 - 127
 Macros 256 - 383 Controller change 87, parameters 0 - 127
 Macros 384 - 511 Controller change 88, parameters 0 - 127
 Macros 512 - 639 Controller change 89, parameters 0 - 127
 Macros 640 - 767 Controller change 90, parameters 0 - 127
 Macros 768 - 895 Controller change 91, parameters 0 - 127
 Macros 896 - 999 Controller change 92, parameters 0 - 127

Real Time Clock

The Real Time Clock option allows you to program cues to playback in real time. That is, you can program a cue to playback automatically at any time of day on any day of the week. For example, you might program the work lights to come on for a choir rehearsal on stage between 7 p.m. and 9 p.m. on Monday and Wednesday. Or, you may want to warm the filaments of your studio instruments 15 minutes prior to your news program.

The Real Time Clock also displays the current time under the display mode label and date-stamps shows when you record them on disk.

You can record up to 10 real time programs in *Expression*. This section includes instructions for creating real time programs and setting the real time clock. The Real Time Clock is an optional accessory that must be installed at the factory.

Creating or editing real time programs

1. Press [Set Up].
2. Select 9, **Edit real time programs**, and press [Enter]. *Expression* displays the following screen.

GRAND MASTER 100%		CLOCK 18:11		PROGRAM
PROGRAM	START CUE	TIME ON	TIME OFF	DAYS OF WEEK
1				
2				
3				
4				
5				
6				
7				
8				
9				
10				

SELECT PROGRAM NUMBER

3. Select a program number, and press [Enter].
4. Enter the cue number you want program to bring up, and press [Enter].
5. Enter the time you want cue to playback. Enter time in military format. For example, enter 8:00 a.m. as 08:00 and 5:15 p.m. as 17:15. Press [Enter].
6. Enter the time you want cue to fade out. Enter time in military format. Press [Enter].

Hint: You can use [Cue] to edit cue numbers and [Time] to edit on and off times.

7. At the day of the week prompt, enter any of the following codes to indicate on which days the cue should run. Then press [Enter].

- 1 - Sunday
- 2 - Monday
- 3 - Tuesday
- 4 - Wednesday
- 5 - Thursday
- 6 - Friday
- 7 - Saturday

To run cue on more than one day of the week, use [And] and [Thru] to select a group of days. For example, to enter Monday through Wednesday and Saturday, enter: [2] [Thru] [4] [And] [7].

8. Press [Enter] to record the program. Or, press [Clear] to cancel it.

Setting Real Time Clock

Follow these steps to set Real Time Clock:

1. Press [Set Up].
2. Select 10, **Set real time clock**, and press [Enter]. *Expression* displays the following screen.

ENTER CURRENT TIME <24 HOUR CLOCK>	
TIME:	18:16
DATE:	23 JAN 91
DAY :	WEDNESDAY

3. At Current Time prompt, enter time in military format. For example, enter 8:00 a.m. as 08:00; and 5:15 p.m. as 17:15. Press [Enter].
4. At Current Date prompt, enter day of the month. Press [Enter].
5. At Current Month prompt, enter one of the following month codes and press [Enter].

1 - January	7 - July
2 - February	8 - August
3 - March	9 - September
4 - April	10 - October
5 - May	11 - November
6 - June	12 - December
6. At current Year prompt, enter the last two digits of the desired year. Press [Enter].
7. At current Day prompt, enter one of the following day codes and press [Enter].

1 - Sunday	5 - Thursday
2 - Monday	6 - Friday
3 - Tuesday	7 - Saturday
4 - Wednesday	
8. Press [Rec] to start clock. Or, press [Clear] to cancel operation and leave clock at previous setting.

Serial Button Protocol

Serial Button Protocol lets you use a host device, such as a personal computer, to send keyboard commands to *Expression*. In effect, the protocol lets you push all the console buttons from the host device.

Serial Button Protocol can be used in architectural applications or any computerized lighting control system.

For more information about the protocol, contact ETC.

Redundant Tracking Backup

Redundant Tracking Backup allows you to connect two *Expression* consoles, one as the master console and the other as the slave (backup). The slave console mimics all key presses from the master. If the backup console detects an interruption in the master console's operation, the slave takes over.

Both consoles begin the performance with the same show loaded. As the performance proceeds, all keystrokes entered on the master console are mimicked on the backup console. Therefore, the backup console is not only synchronized with the performance, but all last minute updates are recorded on both consoles.

Redundant Tracking Backup is a standard feature on *Expression*.

Note: You can use a Concept or Impression to backup an Expression. However, the show cannot include features that are not included on both consoles. For example, if you backup an Expression console with an Impression console, you cannot use more than 150 channels, nor can you use macros or effects.

Using Redundant Tracking Backup

To use Redundant Tracking Backup, follow these steps:

1. Configure consoles as described in the section titled *Installing Redundant Tracking Backup*, on page 2 - 17.
2. Turn both consoles on.

If the master console does not receive any input from the slave console within one minute of initial power up, the following message appears on the screen: **Backup unit is not responding. Backup tracking link has been disabled automatically. (Press 'Clear' to continue.)** Pressing [Clear] removes the message and allows you to use the master console in normal, single console operation.

3. Insert disks into both consoles. The show you load into consoles must be identical and must be recorded on the disks as the same show number as either show one or show two.
4. Read show into master console. All keystrokes on the master console are mimicked on the backup. Therefore, show is read into both consoles at the same time. Continue using master console normally.

If there is a failure in the slave console during operation, or if the communications link between the two consoles is interrupted, the following message appears on the screen: **Backup unit is not responding. Check DIP switches and power for Backup unit. Check serial communications cable. Stand by until communication is established, or press [Clear] to break the backup tracking link.** [Clear] removes the message and allows you to use the master console in normal, single console operation.

5. If it is necessary to use the backup console, you must disconnect the dimmer cables from the master console and insert them in the identical cable connectors in the backup console. You must also connect monitor cables to the slave console if you do not have monitors connected to both consoles.

You may want to use A/B switch boxes for the dimmer and monitor cables to facilitate switch over.

If a disk drive error occurs on either console, the master displays an error message. To resynchronize the two consoles after an error message, press [Clear] on the master.

Print options work only on the master console.

Note: You can force the backup console to take over by turning the master console's power off.

Remote Submasters and Remote Macros

Remote submasters and macros are small, portable control consoles that control submasters and macros from locations up to 1000 feet from your main control console. You can have up to four remote control stations; each one consisting of a remote submaster panel or a remote macro panel, or one of each. The remote submaster panel contains twelve submaster potentiometers that control the console's first 12 submasters. The remote macro control panel contains twelve macro control buttons that allow you to control the first 12 recorded macros.

To activate a remote panel, press the Take Control switch on the remote panel. Pressing the panel's take control switch activates the remote panel controls and deactivates the panel previously in control.

When remote panels are installed, the main control console and remote panels are equipped with Take Control switches. The Take Control switches can be disabled with optional locking key switches. You can activate a panel and lock it in the on position, or deactivate it and lock it off. When a remote panel is locked on, pressing another remote's Take Control has no effect. The main control console's take control switch always overrides remote Take Controls, even if they are locked on.

When a remote control panel is active, the console operates normally, except for its submaster pots, which are disabled. Submaster bump buttons operate normally.

For remote submaster and macro panel installation instructions, see *Chapter 2, Installation*.

chapter 8

reference

This reference chapter lists all *Expression* keys, features and menu options in alphabetical order. Listings include a description of the feature and instructions for using it.

For more instructions on using *Expression* to create shows, you may find the tutorials in *Chapter 4* and *Chapter 5* helpful. For step-by-step instructions on working with cues and submasters see *Chapter 4, Learning the basics*. For step-by-step instructions on tracking, groups, subroutines, autoloads, effects and macros, see *Chapter 5, Learning advanced techniques*.

And

[And] allows you to select a set of channels, cues, dimmers, or steps that has a break in the numerical sequence. You can then enter an intensity level for the set. For example, you can select channels 1 and 7 and 9.

You can also use [And] in conjunction with [Thru] to select a set such as 1 through 10 and 15 through 20.

To select a discontinuous set of cues or channels follow these steps:

1. Press [Chan] or [Cue] (whichever you are selecting).
2. Enter a channel or cue number.
3. Press [And].
4. Enter a second channel or cue number.

Hint: You can combine the use of [And] and [Thru]. For example, [1] [And] [5] [Thru] [9].

Example

[Chan] [1] [And] [5] selects channels one and five.

At

[At] indicates that the next number entered will be an intensity level for selected channels.

You can also use the fader wheel or [Full] to set intensity levels.

1. Select channels.
2. Press [At] to indicate that next number entered will be an intensity level setting.
3. Enter a two-digit intensity level setting for selected channels. Or, if you prefer to enter levels on a scale of 1 to 10 (for example, 1 = 10 percent, 2 = 20 percent, etc.) enter a one-digit level, and press [Enter].

Hint: It is not necessary to use [At] before pressing [Full] or before moving the fader wheel.

Examples

[At] [5][0] or [At] [5] [Enter] sets selected channels at 50 percent.

Autoload

The autoload feature lets you load both fader pairs simultaneously. You can record any cues in an autoload. For example, you might want to run a regular crossfade cue in one fader and an effects cue in the other.

With autoloads you can playback the same effects cue at different rates during different times in the show.

Expression lets you store up to 25 autoloads; they are not cues and are not included in the 400 cue limit.

You can record autoloads in either Stage or Blind. For instructions on creating autoloads, see page 5 - 44 and 5 - 45. For instructions on taking manual control of autoloads, see page 5 - 46.

Playing back autoloads

To playback a recorded autoload:

1. Press [Autoload].
2. Enter autoload number you want to playback.
3. Press either [Go] key.

Example

[Autoload] [1] AB fader [Go] plays back autoload 1 through the AB fader.

Back

[Back] lets you replay previously played cues. This is a handy feature for bows or similar situations.

The back key replays the most recently played cue, regardless of the order in which the cues were recorded in the cue sheet. It then plays subsequent cues in reverse numerical order. For example, if you play cues one, two, three, twenty-two, and sixteen, then press [Back], cue sixteen will fade into cue twenty-two. If you press [Back] again, cue twenty-one will play, not cue three.

Back allows you to play back cues loaded in either fader pair. If you are using only one fader pair, you need only press [Back] to replay the previous cue. If you have cues loaded into both fader pairs, you must press [Back] then the [Go] button below the desired fader pair. If you play cues one, two and three in the AB fader pair and cues six, seven and eight in the CD fader pair, pressing [Back] then the AB [Go] plays back cue two; pressing [Back] then the CD [Go] plays back cue seven.

Cues are played back using the fade and wait times recorded with the cue.

When using both fader pairs, if you press [Back] then decide not to use the function, press [Back] again to exit Back mode.

Note: Each time you press [Back], Expression resets the cue sheet. The cue replayed with Back becomes the first cue in the cue sheet. If you then press [Go] without first pressing [Back], the next numerical cue will play.

Example

[Cue] [1] [Go] plays cue one.
[Go] plays cue two.
[Go] plays cue three.
[Cue] [2][2] [Go] plays cue twenty-two.
[Cue] [1][6] [Go] plays cue sixteen.

[Back] [Go] plays cue twenty-two.
[Back] [Go] plays cue twenty-one.
[Back] [Go] plays cue twenty.

Black out

[Black out] forces all channels to a zero intensity level. All dimmers immediately black out. *Expression* displays the message **Black out** in flashing letters when Black out is active.

To restore channel settings, press [Black out] again.

All stage fixtures remain off until you release the black out. However, you retain control of the console while in black out and can still create or edit cues, groups or submasters.

Examples

[Black out] sets all channels at zero.

[Black out] second press restores channels to previous levels.

Blind

Blind is a display mode that allows you to create, preview or edit cues, submasters, and effects without affecting live fixtures. If you want live control of dimmers, use Stage mode.

When you press [Blind], *Expression* displays the following screen:

GRAND MASTER 100%										BLIND 18:17										CUE 1									
001	02	03	04	05	06	07	08	09	10	11	12	13	14	15	16	17	18	19	20	21	22	23	24	25					
026	27	28	29	30	31	32	33	34	35	36	37	38	39	40	41	42	43	44	45	46	47	48	49	50					
051	52	53	54	55	56	57	58	59	60	61	62	63	64	65	66	67	68	69	70	71	72	73	74	75					
076	77	78	79	80	81	82	83	84	85	86	87	88	89	90	91	92	93	94	95	96	97	98	99	100					
101	02	03	04	05	06	07	08	09	10	11	12	13	14	15	16	17	18	19	20	21	22	23	24	25					
CUE 1										XFAD 00:05/00:05										MT 00:00									
A FADER					B FADER					C FADER					D FADER					CUE/TYPE		UP/DOWN		WAIT		LINK		DELAY	
CLEAR					CLEAR					CLEAR					1		NOT		RECORDED										
1	2	3	4	5	6	7	8	9	10	11	12	SUBMSTR																	
												LEVEL																	
13	14	15	16	17	18	19	20	21	22	23	24	PAGE 1		LOADED															
SELECT CUE NUMBER																													

While in Blind mode there are three other screens that you can display, the Autoload, Subroutines and Effects screens. For descriptions of those screens, see *Chapter 5, Learning advanced techniques*.

In Blind you can perform some actions that you cannot perform in Stage. For example, you can clear cues, groups and submasters and can create effects. See the section titled *Clear* for instructions on clearing cues and submasters.

Note: You must record your work in Blind before selecting a different display mode. If you press [Stage] before recording a look in Blind, you will lose your work.

Bump switches

Bump switches push untimed submasters to 100 percent immediately and hold them at that level for as long as you press the bump switch.

If the submaster has timed fades, pressing the bump switch initiates the upfade. For timed submasters with no wait time, pressing and holding bump switch initiates upfade; releasing the switch begins the downfade.

For submasters with programmed wait times, press and release bump switch to initiate the upfade. Submaster plays with programmed upfade, wait and downfade times. To reverse the direction of the fade, press bump switch again. You can reverse a timed submaster during either its upfade or its downfade. Pressing the bump switch during a wait will interrupt the wait period and start the downfade.

When you press a bump switch, or when a timed submaster is playing back, the LED flashes until you release the key or the fade is complete.

A lit green LED indicates that a regular submaster is recorded in that pot. A lit red LED indicates that an inhibitive submaster is recorded in that pot. If no LED is lit, a submaster has not been recorded in that pot.

Note: You can disable bump switches by selecting the Enable/Disable option from the System Settings Menu. See the section titled Enable/Disable bump switches on page 3 - 15 for more information.

Recording submaster using bump switches

You may also use bump switches to indicate the submaster in which you want to record a current look. To record a pile-on submaster using a bump switch, follow these steps:

1. In either Stage or Blind mode, create a look on the screen.
2. Press [Rec] to indicate that you want to save the look.
3. Press the bump switch of the submaster in which you want to record the look. A lit LED indicates that the submaster is successfully recorded.

To record an inhibitive submaster, follow these steps:

1. In either Stage or Blind mode, select channels you want to include in the submaster.
2. Press [Rec] [Sub] [-] to indicate that you want to record an inhibitive submaster.
3. Press the submaster bump switch where you want to record the inhibitive submaster.

Captured channels

Captured channels are channels that you have selected and that are live on stage. They remain live until you press [Rel] to release them. **Captured channels override all other channel settings** except the Grand Master. For example, if a channel is in a fader at 100 percent and you capture it and set it to 50 percent, *Expression* reads the 50 percent setting.

You can capture channels while in either Stage or Fader mode, but not Blind or Track Sheet modes since they are not live. *Expression* displays captured channels in either red or yellow on a color monitor. Red channels are captured; yellow channels are captured *and* selected.

Selected channels are channels that you have immediate keyboard control over. You can modify selected channels' levels with [Full], [At], [+], [-], or the fader wheel. You can select channels in all display modes. Selected channels are highlighted on a monochrome monitor and are displayed in yellow on a color monitor.

Selected, captured channels are live channels that are under immediate keyboard control. You can *select* channels in Blind, but they won't be captured since Blind mode is not live.

Chan

[Chan] allows you to select channels in all display modes. Pressing [Chan], indicates that the next number entered will be a channel number.

Once channels are selected, you have immediate keyboard control over channel levels. You can use [Full], [At], [+], [-], or the fader wheel to set desired levels.

Selecting channels in Stage, Blind and Fader

To select channels in Stage, Blind or Fader modes follow these steps:

1. Select a display mode.
2. Press [Chan].
3. Enter the channel number you want to select, or if you are selecting a set or range of channels, enter the first channel in the range.
4. If you are selecting a set or a range of channels, use the [And] and [Thru] keys to select channels.

Expression highlights selected channels.

Selecting channels in Track Sheet

Track Sheet displays level settings of one channel for all recorded cues. When you select the Track Sheet display, *Expression* prompts you to enter the channel number you want to display. To change the channel displayed:

1. Press [Chan].
2. Enter the channel number you want to display. *Expression* displays levels settings for the channel you select.

Examples

[Stage] [Chan] [1] [Thru] [5] selects channels 1 through 5.
[Track Sheet] [Chan] [2] displays channel 2 on Track Sheet.

Clear

The gray [Clear]'s primary function is to delete cues and tracks and clear submasters. You can also delete channel tracks using [Clear]. Occasionally an error message may prompt you to press [Clear].

You can also use [Clear] to clear an incorrect level setting and reset it to zero. To do so, select channels, and press [At] [Clear].

Deleting a cue, submaster or group

To delete a cue or clear a submaster, follow these steps:

1. Press [Blind]. You must be in Blind to delete cues or clear submasters.
2. Press [Cue], [Sub] or [Group].
3. Enter the cue, submaster or group number you want to delete. If you are deleting a group, press [Enter] after you enter the group number.
4. Press [Clear].
5. Press [Record] to delete cue, submaster or group. Or, press [Cue], [Sub] or [Group] to restore it.

Clearing channel to extend a track

[Clear] allows you to clear levels from selected channels in a cue, so that levels from the previous cue will be pulled into the displayed cue. If the selected channels were providing new levels that were tracking through subsequent cues, levels from the previous cue will now provide those levels. To extend a track, follow these steps:

1. Press [Blind], and enter cue number you want to modify.
2. Select channels you want to clear.
3. Press [At] [Clear].
4. Press [Track] to clear the selected channels and their tracked levels through subsequent cues. Then press [Enter].

Resetting channels to zero

To set channels to zero, follow these steps:

1. Select channels.
2. Press [At].
3. Press [Clear].

Examples

[Blind] [Cue] [1] [Clear] [Rec] deletes cue 1.

[Blind] [2] [Chan] [1] [At] [0] [0] [Track] [Enter] deletes channel one from cue two and remaining track.

[Chan] [5] [At] [Clear] sets channel five at zero.

Clear fader

The blue [Clear] keys next to fader pairs clear all cue information from faders. The default fader clear time is zero; therefore channels fade immediately. To change fader clear time, follow these steps:

1. Press [Set Up].
2. Select 6, **System Settings**, and press [Enter].
3. Select 3, **Default Fader Clear Time**, and press [Enter].
4. Enter fader clear time in seconds or as a fraction of a second in decimal format. Fade times can be any length of time from .1 second to 99:59 minutes.
5. Press [Enter].

Example

[Set Up] [6] [3] [4] [Enter] resets fader clear time to four seconds.

Clear show from memory

The **Clear show from memory** option on the Set Up Menu clears all cues, submasters, effects, subroutines, groups, autoloads, and real-time programs from memory. It does not clear macros, regions, softpatch or system settings. To use the option, follow these steps:

1. Press [Set Up].
2. Select 8, **Clear show from memory**, and press [Enter]. *Expression* deletes show except macros, regions, softpatch, and system settings.

Example

[Set Up] [8] [Enter] clears show.

Cue

[Cue] allows you to select a cue to display in Blind mode or to playback in Stage mode or to modify from Track Sheet. Pressing [Cue] indicates that the next number entered will be a cue number.

Displaying cues in Blind

To display in Blind mode, follow these steps:

1. Press [Blind].
2. Press [Cue].
3. Enter cue number you want to display. *Expression* displays the channel settings for the cue. Channels are not live.

Channels that were used in the previous cue, but are not included in current cue are displayed with a zero level to indicate a downfade from the previous cue.

Example

[Bind] [Cue] [1] displays cue 1 in Blind.

Selecting cues in Stage

To select a cue to playback in Stage, follow these steps:

1. Press [Stage].
2. Press [Cue].
3. Enter cue number you want to playback next. *Expression* moves the cue you enter to the top of the cue sheet and highlights it.
4. Press either [Go] key. Cue plays back. To avoid fade times, pull fader pair controls down to **0** and back to **10**.

Example

[Stage] [Cue] [1] [Go] plays back cue 1.

Selecting cues in Track Sheet

To select cues while in Track Sheet, follow these steps:

1. Press [Cue].
2. Enter cue numbers and [And] or [Thru] to enter a group of cues.

Example

[Track Sheet] [Cue] [1] [Thru] [5] selects cues 1 through 5 from the Track Sheet.

Numbering cues

Expression has a 400 cue limit per show. However, you can number cues from .1 to 999.9, using up to one decimal place.

Naming cues

Expression's expanded memory features an optional alphanumeric keyboard option. With the keyboard, you can name cues, submasters, groups, and shows. Follow these steps to use the keyboard to assign a name to a cue:

1. Make sure the keyboard is properly connected. See instructions in *Chapter 2, Installation*.
2. Press [Stage] or [Blind].
3. Press [Cue], then enter the number of the cue you want to name.
4. Press [F1] on the keyboard, then enter the desired cue name. See *Chapter 7, Accessories*, page 7 - 3 for more information on naming conventions.
5. Press [Enter] on the keyboard to record the name.
6. Press [Esc] on the keyboard to quit and return to the original display screen.

Delay time

To change the delay time for linked cues or cues linked to macros, follow these steps:

1. Press [Cue], and enter the first cue in the link.
2. Press [Link] twice.
3. Enter the delay time in minutes and seconds.
4. Press [Enter].

Example

[Cue] [1] [Link] [Link] [5] [Enter] enters a delay time of five seconds for cue 1, when cue 1 is already linked to another cue or macro.

Diagnostic system clear

The Diagnostic system clear option erases all cues, groups, submasters, autoloads, macros, and real-time programs, and it resets all system settings to their factory default settings.

Warning: When you initiate a diagnostic system clear, all show data stored in Expression is lost. Save the current show on disk if you do not want to permanently lose it.

The Diagnostic system clear option is included on the System Settings Menu. Follow these steps to initiate the system clear option:

1. Press [Set Up].
2. Select 6, **System Settings**, and press [Enter].
3. Select 16, **Diagnostic System Clear**, and press [Enter]. *Expression* displays the following screen.

```
DIAGNOSTIC SYSTEM CLEAR
WARNING:
THIS FUNCTION WILL CLEAR ALL CUE INFORMATION AND RESET
ALL SYSTEM SETTINGS TO DEFAULTS. CHECK WITH AUTHORIZED
SERVICE CENTER BEFORE USING.
TO CLEAR SYSTEM, PRESS "ENTER" - TO ABORT, PRESS "CLEAR"
```

4. If you are certain you want to initiate the diagnostic system clear, press [Enter]. To cancel the system clear, press [Clear].

Note: You can also force a diagnostic system clear by turning the console off, and pressing and holding down bump switches for submasters 7, 8 and 9 while you turn the power back on. Release the bump switches when the Stage screen is displayed.

Example

[Set Up] [6] [1][6] [Enter] [Enter] performs a diagnostic system clear.

Dim

[Dim] allows you to select a specific dimmer or a group of dimmers. The two times when you need to select dimmers are for softpatching and for unpatching single dimmers. For more information about softpatching, see *Chapter 3, Entering softpatch and system settings*. Unpatching a dimmer is explained below.

[Dim] lets you select a single dimmer and bring it up independent of other dimmers softpatched into the same channel. This is called unpatching a dimmer.

If a channel has more than one dimmer softpatched into it, you may want to unpatch a single dimmer to check individual fixtures, to turn on a work light, or to focus a single fixture. To unpatch a dimmer, follow these steps:

1. Determine which dimmer you want to unpatch. You may want to display the softpatch screen to display the current dimmer to channel patching. To display the softpatch screen, press [Patch].
2. Press [Stage] then [Dim].
3. Enter the dimmer number you want to unpatch. Unpatching does not affect the level at which other dimmers in the channel are set. If you want all other dimmers in the channel off, set channel at zero.
4. To set the unpatched dimmer at full intensity, press [Enter]. Or, to set the unpatched dimmer at less than full, press [At], and enter a two-digit level. Then press [Enter].
5. Press [Dim] [Clear] to restore dimmer to patch. You can perform most other console tasks with dimmer unpatched, then restore the patch at any time. Entering the softpatch screen also restores patch.

Hint: You can perform a dimmer check by pressing [Dim] [1] [Full], and then pressing [Dim] [+], to move to each subsequent dimmer. You can write these key sequences as macros if you use dimmer checks often.

Example

[Stage] [Dim] [1] [Enter] unpatches dimmer one. [Dim] [Clear] restores patch.

Dimmer profiles

Dimmer profiles allow you to select a specific output curve for a dimmer over the range of a fade. This can compensate for nonlinear light outputs from certain types of fixtures or incorporate a preferred response in a fade. If you do not select a dimmer profile, the console defaults to a linear output.

To select a dimmer profile for a specific dimmer, follow these steps:

1. Press [Patch].
2. Press [Dim], and enter dimmer number or a range of dimmer numbers using [And] and [Thru].
3. Press [Type].
4. Enter profile number. Profile numbers are listed on menu at the bottom of the softpatch screen. Each is also described and illustrated below.

- 0 - Linear
- 1 - IES square
- 2 - Slow bottom
- 3 - Fast bottom
- 4 - Slow top
- 5 - Fast top
- 6 - Full at 1%*
- 7 - Preheat 5%[†]‡
- 8 - Preheat 10%[†]‡
- 9 - Hot patch[†]‡

* Dimmer intensity jumps from 0% to 100% at 1% output.

† Dimmer at 5% or 10% whenever console power is on.
Dimmer intensity increases when output exceeds 5% or 10%.

‡ Dimmer at full whenever console power is on.

¶ Affected by [Black Out] but not by Grand Master.

Dimmer profile graphs

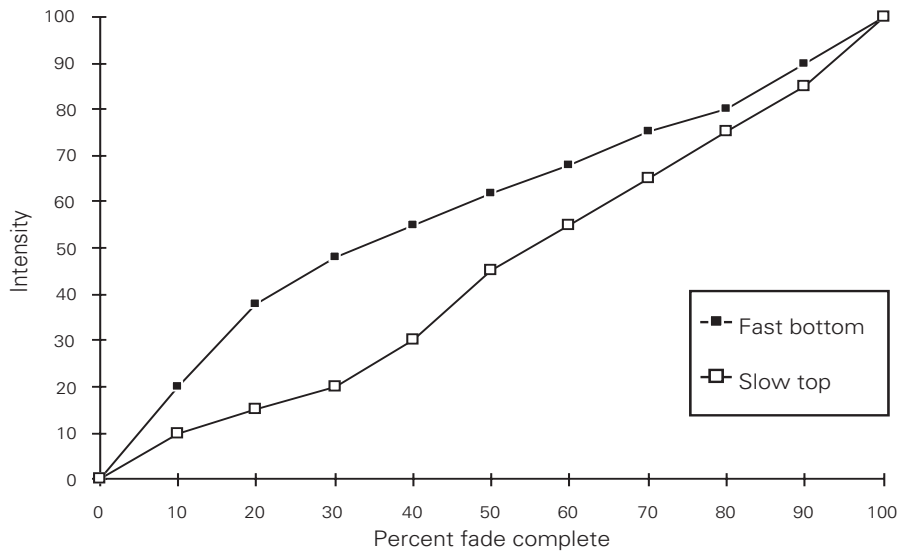
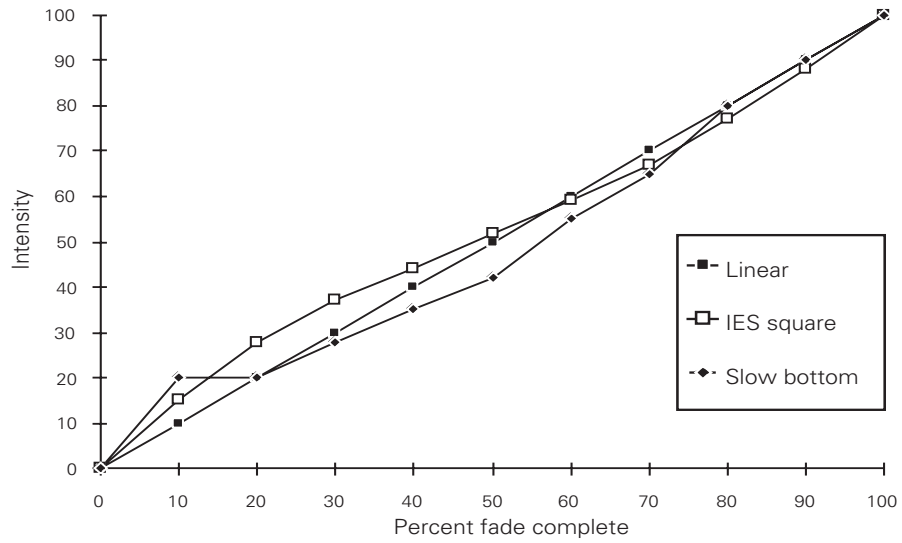

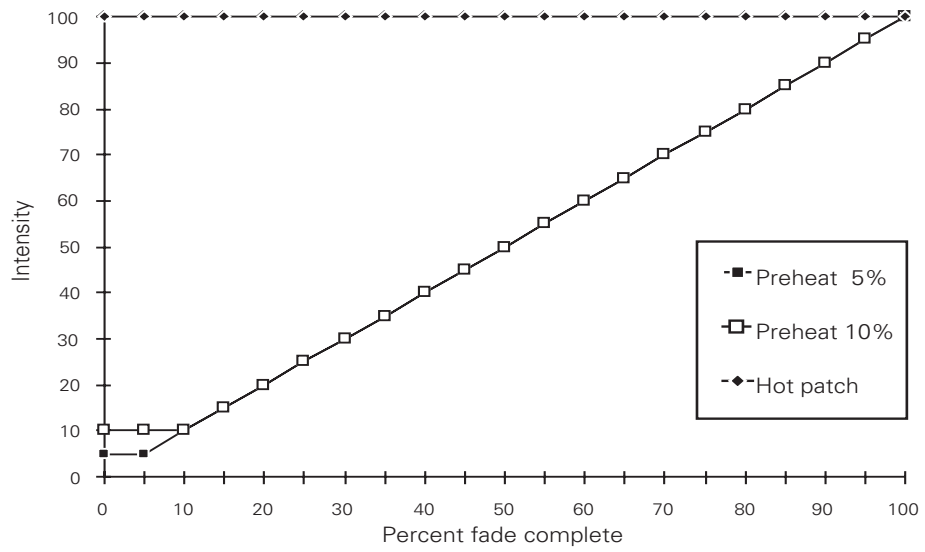
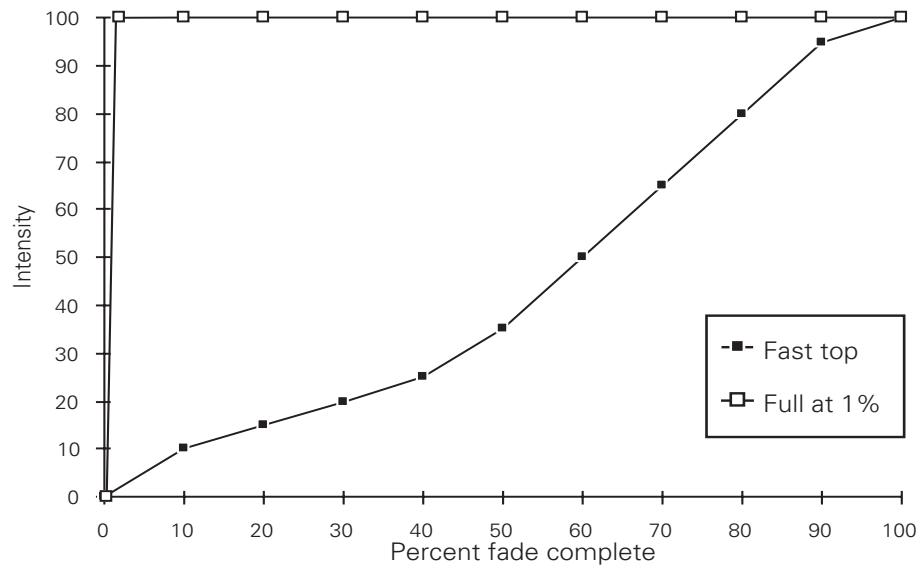

Effects keys

Effects are cues that include a series of steps. The effect plays back the steps to produce one of the special effects described below.

Each effect can hold up to 10 steps, each with up to 10 channels. Steps list channels, the high and low intensity level limits for those channels, and the fade or wait time for those channels. Effects are cues, and are therefore included in the 400 cue limit.

Detailed instructions for working with effects are included in *Chapter 5, Learning advanced techniques*.

To display effects screen press [Blind] [Type] [3] [Enter].

Styles

The following four playback effect styles are available:

Loop

Runs through steps consecutively, returns to the first step and repeats the loop. Channels flash rather than fade between steps. Loop is useful for creating marquee-type effects.

Bounce

Runs through steps in forward and then in reverse order. Channels flash between steps rather than fade. Bounce can be used for marquee or runway effects.

Random

Plays steps back in random order. Channels flash to high and low levels, they do not fade. Random creates lightning, flashing, or strobe effects.

Ripple

Plays steps in random order, but unlike random, channels fade between steps. Ripple creates the effect of flames or water reflections.

Enter

[Enter] functions as an Enter key does on most computer keyboards. It indicates that you have finished entering a number or have completed an operation. The operator prompt line indicates when you should use this key.

Except

[Except] allows you to exclude a subset from active channels when you are recording a cue, group or submaster. You can also use [Except] to exclude a subset of the current selected channels from direct keyboard control.

For example, you may have several submasters active on stage, a cue in a fader pair, and some captured channels. You can use [Except] to record all channels, except a subset that you indicate.

When using [Except], you can designate any recorded set of channels such as cues, groups or submasters, as the *excepted* channels. Or you can designate specific channels by number and [And] and [Thru].

You can also use [Except] when you are selecting dimmers on the softpatch screen or cues on the Track Sheet.

Recording with [Except]

To record a look currently on the screen, except for a subset of the channels, follow these steps:

1. Press [Rec] to indicate that you want to save the current look.
2. Press [Cue], [Group] or [Sub] to indicate how you want to save the look.
3. Enter the cue, group or submaster number.
4. Press [Except].
5. Press any of the following key sequences to delete some of the channels from the look you are recording.
 - Enter channel numbers. You can select groups of channels to exclude by using [And] and [Thru].
 - Press the bump switch of any submasters whose channels you do not want recorded with the look. You can press as many bump switches as you want to increase the number of excluded channels.

- Enter cues or groups by pressing [Cue] or [Group] and entering the cue or group number. To enter more than one cue or group, press [And] between numbers.
6. Press [Enter] to record the look.

Examples

[Rec] [Cue] [2] [3] [Except], bump switch 1, bump switch 4, bump switch 7 [Enter] records the current look as cue 23 except for channels included in submasters 1, 4 and 7.

[Rec] [Sub] [4] [Except] [Group] [3] [Enter] records the current look in submaster 4 except for the channels included in group 3.

[Rec] [Group] [5] [Except] [Chan] [1] [Thru] [9] [Enter] records the current look as group 5 except for channels 1 through 9.

Selecting channels, cues or dimmers with [Except]

When you are selecting channels for a look, cues in the Track Sheet, or dimmers on the patch screen, use [Except] to exclude a subset of the items (channels, cues or dimmers) already selected. Follow these steps to exclude items.

1. When items are selected, press [Except].
2. Press any of the following key sequences to exclude a subset of selected items.
 - Enter channel numbers. You can select groups of channels by using [And] and [Thru].
 - Press the bump switch of any submasters whose channels you do not want recorded with the look. You can press as many bump switches as you want.
 - Enter channels included in cues or groups by pressing [Cue] or [Group] and entering the cue or group number. To enter more than one cue or group, press [And] between numbers.
3. Complete action with the remaining set of selected items. For example, set channel levels or assign dimmers to channels.

Expand

[Expand] allows you to toggle between 125-channel display and 250-channel display in Stage, Blind and Fader modes.

To expand the standard 125 *Expression* channel display screen, press [Expand]. To return screen to 125-channel display, press [Expand] again.

Fader display

[Fader] displays the Fader mode screen. Fader mode displays captured channels and channels currently in either one or both fader pairs. Like Stage, Fader mode is live. You can select and capture channels and make live adjustments to them. You can save looks you create in Fader as cues, groups or submasters.

Fader mode can display the output of one fader pair at a time or both at the same time. This allows you to modify a cue that has played back in one fader pair and record it without also recording the output from the other fader pair. Fader mode also lets you combine the output of both fader pairs, while eliminating the submaster outputs.

When you press [Fader], *Expression* displays channels in the AB fader pair. The operator prompt line displays the message, **Select fader number (1-AB fader, 2-CD fader, 3-AB/CD fader)**. Press [1] to display channel settings currently stored in the AB fader; press [2] to display channel settings in the CD fader; or press [3] to display channels in both fader pairs.

To clear a fader pair, press the blue [Clear] next to the pair.

Fader wheel

The fader wheel gives you incremental, proportional control of selected channels' intensity levels. When selected channels are displayed on your screen, regardless of what mode *Expression* is in, you can move the fader wheel to adjust level settings.

The fader wheel is speed sensitive. Move the wheel quickly to make large adjustments or slowly to make fine adjustments.

Flash

[Flash] pushes selected channels to a level of either zero or full depending on their level when you press [Flash]. If selected channels are set at a level from one to 50 percent, press [Flash] to flash them to full. If selected channels are set at a level from 51 percent to full, press [Flash] to flash them to zero. Channels remain at flash level until you release the key.

One application of [Flash] is identifying which lamps are controlled by a channel. To do so, select desired channel, and press [Flash].

Flexichannel

When Flexichannel mode is enabled, *Expression* displays only selected channels and channels that are part of a recorded cue, submaster, group, or effect; channels not used in the current show do not appear on the display screen.

Flexichannel is a feature of *Expression*'s expanded memory option. It is available only when expanded memory is installed.

If you are creating a new show in Flexichannel mode, and have not selected or recorded any channels, no channels appear on the display. As you create a show, the channels you select appear. If you enable Flexichannel once you have started working on a show, channels not recorded as part of a cue, submaster, group, or effect are removed from the display.

If Flexichannel is enabled and you read a show into the console from disk, only recorded channels will appear in the display.

Display mode information is not recorded as part of a show. Regardless of the display mode selected when you record a show, the *Expression* console returns to the display mode you used last when you turned it off.

Follow these steps to enable or disable the Flexichannel display mode:

1. Press [Setup].
2. Select 6, **System settings**, and press [Enter].
3. Select 18, **Enable/disable Flexichannel**, and press [Enter].
4. Press [1] [Enter] to enable Flexichannel, or [0] [Enter] to disable it.

Flexichannel displays any channels that you have recorded or selected at any time while working on show. To clear the channels that you have selected, but chose not to record, reenable Flexichannel from the System Settings Menu.

Note: When using [Thru] to select a range of channels in Flexichannel, you must press [Thru] twice. See the section titled Thru in this chapter for more information.

Full

[Full] enters full intensity for all selected channels. [Full] works in all display modes. When you use [Full], you do not have to press [At].

You can change the level [Full] enters by changing the default setting. For example, you could change the default full level to 85; pressing [Full] would then enter 85 for all selected channels. Follow these steps to change the default setting:

1. Press [Set Up].
2. Select 6, **System Settings**, and press [Enter].
3. Select 1, **Default Full Level**, and press [Enter].
4. Either enter a two-digit intensity level, or press [Full] to set level at 100 percent.
5. Press [Enter].

When the [Full] default is set below 100 percent, you can still set levels at any level up to 100 by using [At] and the numeric keypad or the [+] and [-] keys.

Examples

[Chan] [5] [Thru] [1][0] [Full] sets channels 5 through 10 at 100 percent.

[Set Up] [6] [1] [8][5] [Enter] sets default full levels to 85 percent.

Go

The [Go] keys initiate the playback of cues. When you press a [Go] key, the cue highlighted on the cue sheet begins playing back in the fader pair.

If you have pressed [Hold] to interrupt the playback of a cue, press [Go] to resume the fade.

*Hint: To go to a cue out of sequence, press [Cue], enter the cue number, and press [Go]. To push the levels to their full recorded levels immediately (avoiding the fade time), push fader controls to **0** and back up to **10**.*

Example

[Cue] [5] [Go] plays back cue 5. Pressing [Go] again plays the next cue on the cue sheet.

Grand Master

The Grand Master pot overrides all other channel level settings except [Black out]. Normally the Grand Master is set at **10** (100 percent) so that all channels operate at 100 percent of their set levels. When the Grand Master is set at a level less than **10**, channel outputs equal current settings multiplied by the percentage level at which the Grand Master is set.

The current Grand Master setting is displayed in the upper left corner of the screen. It is not displayed when [Black out] is activated, in which case **Black out** flashes in the upper left corner.

Group

[Group] allows you to store groups of channels at proportional levels. When you select a group, *Expression* selects its channels. If you then press [At] and enter a level, the console enters at percentage of the group's recorded levels. If you press [Enter] instead of [At], the group's proportional levels are imposed on the channels' current levels.

The fader wheel then adjusts levels in the same proportions at which you recorded the group's channels.

For example, assume you save channels 1 through 9 at full and channels 10 through 20 at 50 percent. When you move the fader wheel, channels 1 through 9 are twice the intensity of channels 10 through 20. In other words, [Group] retains the channels' relative levels.

If you continue to increase the intensity levels after channels with the highest relative level reach full, the relative levels are distorted. Channel levels continue to increase until all channels are at full.

For instructions on using [Group] see *Lesson 3, Using Group in Chapter 5, Learning advanced techniques*.

Example

[Group] [1] [Enter] displays group 1.

[Cue] [1] [Group] [1] [At] [5][0] displays cue 1, then adds group 1 to it and sets group channels at 50 percent of their recorded levels.

Numbering groups

The sum of groups and cues in a show cannot exceed 400. However, you can use any numbers between 1 and 999, to number groups. Group numbers are independent of cue numbers.

Naming groups

Expression's expanded memory features an optional alphanumeric keyboard option. With the keyboard, you can name cues, submasters, groups, and shows. Follow these steps to use the keyboard to assign a name to a group:

1. Make sure the keyboard is properly connected. See instructions in *Chapter 2, Installation*.
2. Press [Stage] or [Blind].
3. Press [Group], then enter the number of the group you want to name.
4. Press [F1] on the keyboard, then enter the desired group name. See *Chapter 7, Accessories*, page 7 - 3 for more information on naming conventions.
5. Press [Enter] on the keyboard to record the group name.
6. Press [Esc] on the keyboard to quit and return to the original display screen.

Group Sheet

Group Sheet is a feature of *Expression's* expanded memory option. It is available only when expanded memory is installed.

The group sheet allows you to display all recorded groups on screen. To display Group Sheet, press [Blind] [Group] [Page]. Group Sheet displays the first 32 recorded groups. To display additional groups, press [Blind]. Press [-] to return to Blind, or press another stage display button to move to another display mode.

Group Sheet also displays group names if you have an alphanumeric keyboard.

Help

[Help] provides a brief explanation for all key functions. To display help screens:

1. Press [Help].
2. Press any key on the console. *Expression* displays a description of the key you pressed.

Help screens are not available for menu options.

Example

[Help] [Set Up] displays the Set Up help screen.

Hold

[Hold] stops the playback of the cue in the fader pair above the key. To resume the playback, press [Go]. To cancel the playback, press [Hold] again. The faders hold current levels until you play another cue or clear the fader pair.

Example

[Cue] [1] [Go] [Hold] begins playing back cue 1 and then puts it on hold.

Infinite wait times

Expression lets you enter an infinite wait time on submasters. An infinite wait time holds a timed submaster for an indefinite period of time. To start the downfade, press bump switch again.

1. Press [Time].
2. Enter upfade time, and press [Enter].
3. Press [-], and press [Enter]. *Expression* displays **INF** to indicate an infinite wait time.
4. Enter downfade time, and press [Enter].

Example

[Sub] [1] [Time] [5] [Enter] [-] [Enter] [Enter] enters five second up and down fade times and an infinite wait time for a new submaster.

Inhibitive submasters

Inhibitive submasters are submasters that include a set of channels whose levels you can limit to a specific level. Inhibitive submasters work similarly to the Grand Master, but for a limited number of channels. When an inhibitive submaster is set at **10** (100 percent), no channels are affected by it. When the submaster is set at any level less than **10**, channels included in the submaster are limited to that percentage.

Submasters 13 through 24 can be programmed as either pile-on or inhibitive submasters. All other submasters always function as pile-ons.

Inhibitive submasters override channel levels produced by all other faders. Captured channels are unaffected by inhibitive submasters.

Each channel can be included in only one inhibitive submaster. If you assign a channel to an inhibitive submaster that is already included in another, *Expression* removes it from the first one, and adds it to the submaster that you most recently recorded.

To save a group of channels in an inhibitive submaster follow these steps:

1. Select desired channels.
2. Press [Rec] [Sub] [-].
3. Press the bump switch of an available submaster (only numbers 13 through 24 may be used for inhibitive submasters). If you select a bump switch of a recorded submaster, the new inhibitive submaster overwrites the old one.

A lit red LED on a bump switch indicates that an inhibitive submaster is recorded.

Impression has two pages of submasters. Follow the procedure on page 4 - 40 and 4 - 45 to record submasters to a specific submaster pages.

*Note: Leave inhibitive submasters at **10** (100 percent) until you want to inhibit channels. Otherwise channels may be missing from your cues. If you seem to be missing some channels, check your inhibitive subs!*

Link

[Link] joins two or more recorded cues to one another so that they playback automatically in the sequence you link them. Each cue in the link counts as one cue in the 400 cue limit.

[Link] also allows you to link macros to cues. When you link a macro to a cue, it begins, as linked cues do, after the duration of the delay time.

To link cues to cues or cues to macros, follow these steps:

1. In either Stage or Blind, press [Cue].
2. Enter number of first cue you want in linked sequence, and press [Enter].
3. Press [Link].
4. To link cue to another cue, press [Cue]. Then enter number of second cue in linked sequence, and press [Enter].

To link cue to a macro, press [Enter Macro]. Then enter the number of the macro you want linked to the cue, and press [Enter].

5. Enter desired delay time, and press [Enter].

The delay time is the length of time between the beginning of a cue and the beginning of the cue or macro to which it is linked. *Expression* calculates and enters a default delay time. The default delay time is the total running time of the previous cue in the sequence.

The total running time is whichever is longer of the upfade time and the sum of the wait and downfade times. The default delay time plays the entire first cue, and then plays the second cue immediately afterward.

6. To link more than two cues, repeat steps two through five for each link.

Note: To change the delay time for a cue that is already linked to another cue or macro, select the first cue in the link, press [Link] twice, enter the delay time, and press [Enter].

Example

[Cue] [1] [Link] [2] [Enter] [5] [Enter] links cue 1 to cue 2 with a five second delay time between the cues.

[Cue] [1] [Link] [Link] [6] changes the delay time to six seconds.

Deleting links

To delete link information from a cue, follow these steps:

1. In either Stage or Blind, press [Cue].
2. Enter number of first cue from which you want to delete link information, and press [Link].
3. Press [Clear].

Example

[Cue] [1] [Link] [Clear] clears link information from cue 1.

Macros

Macros allow you to store a sequence of keystrokes and play them back by starting the sequence with just one keystroke.

For example, you may want to check each of your channels by bringing each up for a couple of seconds. Rather than manually bringing each up, you can create a macro to automatically bring each channel up for any period of time, and then move on to the next one.

Chapter 5, Learning advanced techniques includes detailed instructions for working with macros.

Minus (-)

The minus key [-] decreases the value of a highlighted number by one. The value could be a channel number, a cue number, a level setting, or any other type of number that is highlighted on the screen. The plus key [+] increases the value of a highlighted number by one.

For example, when the LED on [Chan] is lit and you are selecting channels, press [-] to highlight the preceding channel (or [+] to highlight the next channel). Or once you have selected the channels you want, press [At] to indicate that you are entering levels. Then use [-] and [+] to adjust the level one point at a time.

Shortcut: To select all channels with the minimum keystrokes, press [Chan], [1], [Thru], [-]. This selects all channels from one to the channel before it, which Expression reads as the last channel.

Example

[Chan] [1] [At] [-][-][-] decreases channels one's intensity level one point at a time.

Page

Page has two functions: one is to select submaster pages; the other is to display the Submaster and Group Sheets.

Submaster pages

Expression has two *pages* of submasters. Each page stores a complete set of recorded submasters. This doubles the number of available recorded submasters.

Expression displays the message **Page 1 Loaded** (or **Page 2 Loaded**) in the message display window to indicate which page is currently active. To switch pages, press [Page], enter the new page number, and press [Enter]. The message indicates the new page number and displays the message **Loading** instead of **Loaded**.

When you load a new page, any submasters set at a level above zero remain on stage until you pull them down to zero. This prevents the stage from going black when you switch pages. Submasters remaining from the previous page are indicated by flashing bump switch LEDs.

Submasters on the new page are not loaded into pots until you pull them down to zero. The message **Loading** remains flashing on the screen until all submasters on the new page are loaded.

Warning: Changing pages momentarily interrupts any fades in progress.

[Page] also allows you to create a submaster while one page is loaded, and to record it on the other page of submasters. To do so, follow these steps:

1. Create submaster look.
2. Press [Rec].
3. Press [Page], and enter the page number on which you want to record the submaster.

4. Press the submaster bump switch in which you want to record look.

Shortcut: To load the other page, press [Page] [+] [Enter].

Hint: If you use both pages of submasters, you may want to record the following macros: [Rec] [Page] [1], and [Rec] [Page] [2].

Example

[Rec] [Page], entering page number, and pressing a bump switch records a submaster on the submaster page you designate.

Displaying Submaster and Group Sheet

Submaster Sheet and Group Sheet are features of *Expression's* expanded memory option. They are available only when expanded memory is installed.

To display Submaster Sheet, press [Blind] [Sub] [Page]. Press [Page] to alternate between the two pages of Submaster Sheet.

To display Group Sheet, press [Blind] [Group] [Page]. Press [Page] to alternate between the two pages of Group Sheet.

Patch

[Patch] displays the softpatch setup screen. The softpatch setup screen allows you to assign dimmers to channel numbers. The softpatch screen is illustrated below. For complete instructions on softpatching, see *Chapter 3, Entering softpatch and system settings*.

GRAND MASTER 100%						SOFTPATCH	DIMMER
CHN	DIMMER	LEVEL/PROFILE					
01	1	251	501	751	1001		
02	2	252	502	752	1002		
03	3	253	503	753	1003		
04	4	254	504	754	1004		
05	5	255	505	755	1005		
06	6	256	506	756	1006		
07	7	257	507	757	1007		
08	8	258	508	758	1008		

PROFILES:
 0-LINEAR 1-IES SQUARE 2-SLOW BOTTOM 3-FAST BOTTOM 4-SLOW TOP
 5-FAST TOP 6-FULL AT 1% 7-PREHEAT 5% 8-PREHEAT 10% 9-HOT PATCH

SELECT DIMMER NUMBERS, THEN PRESS "ENTER" TO ASSIGN TO A CHANNEL,
 OR PRESS "AT" TO ASSIGN A LEVEL, OR PRESS "TYPE" TO ASSIGN A PROFILE

Plus (+)

The plus key [+] increases the value of a highlighted number by one. The value could be a channel number, a cue number, a level setting, or any other type of number that is highlighted on the screen. The minus key [-] decreases the value of a highlighted number by one.

For example, when the LED on [Chan] is lit and you are selecting channels, press [+] to highlight the next channel (or [-] to highlight the preceding channel). Or, once you have selected the channels you want, press [At] to indicate that you are entering levels. Then use [-] and [+] to adjust the level one point at a time.

Example

[Chan] [1] [At] [+] [+] [+] [+] increases channel one's intensity level one point at a time.

Potentiometers (Pots)

Potentiometers, commonly referred to as *pots*, are sliding fader controls.

The AB and CD fader pairs and the Grand Master are potentiometers. These pots have special functions on *Expression* and are described in separate sections of this chapter, *Timed fader pairs* and *Grand Master*.

Numbers next to submaster pots indicate the percentage of the recorded levels at which the submaster is set. Scale numbers are divided by 10. For example, if pot is set at **5**, the submaster is output at 50 percent of recorded levels.

Power

The power switch is key operated. Both keys shipped with your console work in the power switch. To turn the console on, insert the key, and turn it to the **ON** position.

To turn the console off, insert the key, and turn it to the **OFF** position.

We recommend that you turn the console power switch to the **OFF** position before you plug or unplug the power cable.

Warning: Always remove keys from console before shipping.

Rec

[Rec] indicates that you want to save a look that is currently on stage or on the screen as a cue, group, submaster, or autoload. When you record a cue using [Rec], levels are recorded only in the specified cue.

To save a look, press [Rec]. *Expression* assumes that you want to save the look to the current mode you are in. For example, if the [Cue] LED is lit, *Expression* assumes you want to save the look as a cue when you press [Rec]. However, you can save a look in any of the preceding forms, regardless of the active mode. In fact, you can save the same look in as many different forms as you wish. To record a look:

1. Press [Rec].
2. If you want to save the look in the same format indicated in the operator prompt, enter a cue, group, submaster or autoload number.

If you want to save the look in a format other than that indicated in the operator prompt, press the appropriate key to indicate what form you want to save the look in [Cue], [Group], [Sub] or [Autoload].

3. Enter a number to identify the look you saved, and press [Enter].

You can also indicate what form you want to save the look in before you press [Rec]. If you try to record a look with a used number, *Expression* displays the message, **Cue recorded**, (or whatever form you are saving) flashing on the operator prompt line. If you press [Enter], the new look will replace the previously saved look. To cancel the operation, press [Clear]. You can then enter a different identification number for the look.

Note: If you record a modified cue that is in a playback fader pair, the changes are reflected in the fader. That is, when you release the channels that you modified, the changes remain on stage.

Example

[Rec] [Cue] number [Enter], or [Rec] number [Cue] [Enter] both record cues.

Record

The key switch labeled **Record** lets you disable the record function. When the switch is set at **On** you can record all show information as described in this manual. When switch is in the **Lock** position, all playback functions work, but you cannot change or record show information from the show in memory.

Rel

[Rel] releases captured channels. Captured channels are live channels that you have selected in Stage or Fader modes. Captured channels may or may not be under direct control of the keyboard.

When you press [Rel], *Expression* first releases captured channels that are under direct keyboard control (selected channels). If you press [Rel] again, *Expression* releases all remaining captured channels.

Captured channels always take precedence over other controls. For example, assume a channel is included in a submaster which sets it at 75 percent. If you capture the same channel and set it to 50 percent, the 50 percent setting takes precedence. When you release it, it returns to the level determined by other outputs.

Note: You can release a subset of all captured channels by selecting the channel(s) and pressing [Rel]. Other channels remain captured.

Setup

[Setup] displays the Setup Menu, which is illustrated below. The Setup Menu provides access to disk options, System Settings Menu, print options, clear cues option, real-time clock option, macro options and Designer's Worksheet options.

Each of these features is described in detail elsewhere in this manual. The following table indicates where each is located.

GRAND MASTER 100%		SETUP 18:19	MENU
SELECT	FUNCTION		
1	RECORD SHOW ON DISK		
2	READ SHOW FROM DISK		
3	VERIFY SHOW ON DISK		
4	ERASE SHOW ON DISK		
5	FORMAT DISK		
6	SYSTEM SETTINGS		
7	PRINT FUNCTIONS		
8	CLEAR SHOW FROM MEMORY		
9	EDIT REAL TIME PROGRAMS		
10	SET REAL TIME CLOCK		
11	CLEAR MACRO BUTTONS		
12	CLEAR DESIGNER'S WORKSPACE		
13	EDIT MACRO BUTTONS		
14	EDIT DESIGNER'S WORKSPACE		

SELECT FUNCTION NUMBER, THEN PRESS "ENTER"
(SETUP FUNCTIONS STOP ALL FADES)

Disk options	<i>Chapter 6, Using print and disk options, page 6 - 15.</i>
System settings	<i>Chapter 3, Entering softpatch and system settings. Chapter 8, Reference, page 8 - 66.</i>
Print functions	<i>Chapter 6, Using print and disk options.</i>
Clear show from memory	<i>Chapter 8, Reference, page 8 - 16.</i>
Edit Real-time programs	<i>Chapter 7, Accessories, page 7 - 18.</i>
Set Real-time clock	<i>Chapter 7, Accessories, page 7 - 20.</i>
Macro options	<i>Chapter 5, Learning advanced techniques, page 5 - 47.</i>
Designer's Worksheet options	<i>Chapter 7, Accessories, page 7 - 5.</i>

Solo

[Solo] lets you select a channel or a group of channels and suppress all others to a level of zero. [Solo] is useful for selecting part of a look currently displayed on your screen (in any mode) and recording only that portion.

You may also want to use [Solo] to isolate a subset of a live look to readjust or refocus those channels without the other channels interfering. Follow these steps to select a subset of channels from a display screen:

Using [Solo] in Stage

1. Select the channels you want to isolate.
2. Press [Solo]. Selected channels remain at current levels; all other channels are suppressed to zero.
3. Now you can work with the selected channels live, save them as a cue, group or submaster, or use them as you would any other set of selected channels.
4. To restore the full set of channels, press [Solo] again. The changes you made are reflected on the screen.

Using [Solo] in Blind or Track Sheet

1. Select a subset of the current channels displayed.
2. Press [Solo]. All unselected channel levels are removed from the screen.
3. You can now save the selected channels as a cue, group or submaster.
4. Press [Solo] again to delete all remaining channel settings. Or, press [Cue] to restore original settings.

Examples

[Stage] [Chan] [1] [Thru] [5] [Solo] removes all channels except 1 through 5 from the Stage. [Solo] again restores the original look.

[Blind] [Cue] [3] [Chan] [1] [Thru] [5] [Solo] removes all channels except 1 through 5 from screen. [Solo] again removes all channels from screen.

Stage

Stage mode gives you live control of all channels. The Stage mode screen displays the final output level for all channels. The levels displayed in Stage take into account recorded submaster levels, pile-on submaster settings, inhibitive submasters settings, cues loaded in fader pairs, captured channels, and grand master setting. A Stage mode screen is displayed below.

GRAND MASTER 100%										STAGE										CHANNEL 0				
NOT RECORDED										18:52														
001	02	03	04	05	06	07	08	09	10	011	12	13	14	15	016	17	18	19	20	021	22	23	24	025
026	27	28	29	30	031	32	33	34	35	036	37	38	39	40	041	42	43	44	45	046	47	48	49	050
051	52	53	54	55	056	57	58	59	60	061	62	63	64	65	066	67	68	69	70	071	72	73	74	075
076	77	78	79	80	081	82	83	84	85	086	87	88	89	90	091	92	93	94	95	096	97	98	99	100
101	02	03	04	05	106	07	08	09	10	111	12	13	14	15	116	17	18	19	20	121	22	23	24	125
CUE 1										XFAD 00:05/00:05										WT 00:00				
A FADER					B FADER					C FADER					D FADER					CUE/TYPE				
CLEAR					CLEAR					CLEAR					I					UP/DOWN				
																				WAIT				
																				LINK				
																				DELAY				
1	2	3	4	5	6	7	8	9	10	11	12	SUBMSTR												
										LEVEL														
13	14	15	16	17	18	19	20	21	22	23	24	PAGE 1												
										LOADED														
SELECT CHANNEL NUMBERS																								

Step/Part

The Step/Part key is used in editing subroutines and effects, and in creating and editing multipart cues. For information on using Step/Part to edit effects, see page 5 - 34. For information on using Step/Part to edit subroutines, see page 5 - 40. Information on using Step/Part to create and edit multipart cues begins on page 5 - 4.

Examples

[Blind] [Cue] [1] [Step/Part] [1] displays step 1 of subroutine cue 1 in Blind.

[Blind] [Cue] [2] [Step/Part] [1] displays step 1 of effect cue 2 in Blind.

[Stage] [1] [Thru] [5] [Full] [Rec] [3] [Step/Part] [1] [Enter] records channels 1 through 5 at 100 percent as part 1 of cue 3.

Sub

Pressing [Sub] indicates that the next number entered will be a submaster number. You may want to select a submaster to display it in Blind, or you might use [Sub] when you save a look in a submaster.

Press [Sub] and then the submaster number you wish to select.

For detailed instructions on working with submasters, see *Chapter 4, Learning the basics*.

Example

[Blind] [Sub] [1] displays submaster 1 on the Blind mode screen.

[Rec] [Sub] [2] records the current look as submaster 2.

Submaster Sheet

The Submaster Sheet lists all submasters. Page one and two are displayed separately.

Press [Blind] [Sub] [Page] to display Submaster Sheet. Press [Page] to toggle between Submaster Sheet for page one and page two.

All 24 submaster pots per page are represented in the Submaster Sheet. Submasters with recorded levels are displayed in blue; those with no recorded levels are displayed in green. Inhibitive submasters are displayed in red. If a submaster is recorded with specified upfade and downfade times, the times are displayed. Submaster names are also displayed if alphanumeric keyboard is installed.

System Settings Menu

The System Settings Menu includes options for setting default values, softpatch customizing options, system configuration options, and access to the Designer's Worksheet options menu. The chart on the next page indicates where each menu option is described in this manual.

To display the System Settings Menu, follow these steps:

1. Press [Set Up].
2. Select 6, **System Settings**, and press [Enter]. The System Settings Menu is displayed below.

GRAND MASTER 100%		SYSTEM SETTINGS	MENU
SELECT	FUNCTION		
1	DEFAULT FULL LEVEL		
2	DEFAULT UP/DOWN TIMES		
3	DEFAULT FADER CLEAR TIME		
4	CUSTOMIZE CHANNELS		
5	SELECT MIDI CHANNEL		
6	LEVEL/PROPORTIONAL RATE OVERRIDE		
7	CUSTOMIZE DIMMERS		
8	DEFAULT SOFTPATCH		
9	DEFAULT DIMMER PROFILES		
10	SERIAL/PARALLEL PRINTER		
11	COLOR/MONochrome MONITOR		
12	FAST/FULL BOOT TEST		
13	ENABLE/DISABLE REMOTE SUBMASTERS		
14	ENABLE/DISABLE BUMP SWITCHES		
15	ENABLE/DISABLE INFRARED CONTROL		
16	DIAGNOSTIC SYSTEM CLEAR		
17	DESIGNER'S WORKSHEET OPTIONS		
18	ENABLE/DISABLE FLEXICHANNELS		

SELECT FUNCTION NUMBER, THEN PRESS "ENTER"
(PRESS "CLEAR" TO RETURN TO SETUP MENU)

System setting options

Default full level	<i>Chapter 3, Entering softpatch and system settings, page 3 - 14.</i>
Default up/down fade times	<i>Chapter 3, Entering softpatch and system settings, page 3 - 14.</i>
Default fader clear time	<i>Chapter 3, Entering softpatch and system settings, page 3 - 15.</i>
Customize channels	<i>Chapter 3, Entering softpatch and system settings, page 3 - 3.</i>
Select MIDI channel	<i>Chapter 7, Accessories, page 7 - 15.</i>
Level/proportional rate override	<i>Chapter 4, Learning the basics, page 4 - 30.</i>
Customize dimmers	<i>Chapter 3, Entering softpatch and system settings, page , 3 - 3 and 3 - 5.</i>
Default softpatch	<i>Chapter 3, Entering softpatch and system settings, page 3 - 3.</i>
Default dimmer profiles	<i>Chapter 3, Entering softpatch and system settings, page 3 - 10.</i>
Serial/parallel printer	<i>Chapter 2, Installation, page 2 - 10.</i>
Color/monochrome monitor	<i>Chapter 2, Installation, page 2 - 6.</i>
Fast/full boot test	<i>Chapter 2, Installation, page 2 - 7.</i>
Enable/disable remote submasters	<i>Chapter 7, Accessories, page 2 - 20.</i>
Enable/disable bump switches	<i>Chapter 3, Entering softpatch and system settings, page 3 - 15.</i>
Enable/disable Infrared Remote Focus Unit	<i>Chapter 7, Accessories, page 2 - 19.</i>
Diagnostic system clear	<i>Chapter 8, Reference, page 8 -21.</i>
Designer's Worksheet options	<i>Chapter 2, Installation, page 2 - 15.</i>
Enable/disable Flexichannel	<i>Chapter 7, Accessories, page 3 - 16.</i>

Thru

[Thru] allows you to select a range of channels or cues. You can then enter an intensity level for the entire range at one time. For example, you can select channels 1 through 10.

You can also use [Thru] in conjunction with [And] to select a set such as 1 through 10 and 15 through 20.

To select a range of cues or channels follow these steps:

1. Press [Chan] or [Cue] (whichever you are selecting).
2. Enter a cue or channel number.
3. Press [Thru]. If you are using Flexichannel, press [Thru] twice.
4. Enter another cue or channel number. *Expression* selects the entire range.

Example

[Chan] [1] [Thru] [5] [And] [1][0] selects channels 1 through 5 and 10.

Time

[Time] lets you modify the upfade, downfade and wait times for individual cues and submasters. To modify fade and wait times, follow these steps:

1. Press [Cue] or [Sub], and enter the cue or submaster number you want to modify.
2. Press [Time].
3. Enter upfade time in seconds and minutes or as a fraction of a second in decimal format (Cue fade times can range between 00:00 and 99:59 minutes. Submaster fade times are limited to a maximum of two minutes.) Then press [Enter].
4. Enter downfade time for a cue, or a wait time for a submaster. Then press [Enter]. You can enter time in minutes and seconds or as a fraction of a second in decimal format
5. Enter wait time for a cue, or a downfade time for a submaster. You can enter time either in minutes and seconds or as a fraction of a second in decimal format.

Cue wait time is length of time between the *beginning of upfade* and the beginning of the downfade. Submaster wait time is the length of time between the *end of the upfade* and the beginning of the downfade.

You can set an infinite wait time for submasters, for more information see page 8 - 44.

Example

[Cue] [1] [Time] [5] [Enter] [Enter] [1][0] enters up and down fade times of 5 seconds and a wait time of 10 seconds.

Timed fader pairs

The AB and CD fader pairs are timed faders through which you can play back recorded cues. The two fader pairs are independent of each other. You can playback cues in both fader pairs at the same time. The fader pairs operate in two different modes: level override and proportional rate override.

When you turn *Expression* on, it defaults to the fader mode in effect the last time you used the console. You can select another fader mode from the System Settings Menu.

Note: Executing a Diagnostic System Clear from the System Settings Menu resets the faders to level override mode.

The procedure for playing back cues is the same in both modes. To playback the highlighted cue in the cue sheet, press the [Go] key for the fader pair in which you want to play the cue. To override the timed fader and play a cue manually, set the cross faders to zero, then press [Go]. This enables you to control the fade manually, using the faders.

The principal difference between the two modes is that in level override you can use the faders to manually control the fade levels. In proportional rate override you use can use the faders to modify the recorded fade rate.

Select level or proportional rate override modes from the System Settings Menu. See page 8 - 57 for more information on System Settings Menu options.

In level mode, move the faders to the lit LED's to take manual control of the fade. Once you do this you can control the upfade and downfade levels by manually moving the faders. The left (A and C) faders control the upfade levels; the right (B and D) faders control the downfade. Once you have completed the fade you can not reverse it.

In proportional rate override, move the faders below **5** to take control of the fade rate. Once you do this, the upfade and downfade rate are modified by the position of the faders. The left (A and C) faders control the upfade rate; the right (B and D) faders control the downfade rate. You can set the fade rate between 0 (Stop) and 100 (Instantaneous).

Note: You can return to level override by pressing [Hold] [Hold].

Fader pair function for linked cues, effects, subroutines, and autoloads

When you playback linked cues, effects, subroutines, or autoloads containing linked cues, the left fader controls intensity levels. The right fader controls the playback rate. When you begin the cue fade, *Expression* plays it back at the recorded rate; the LED strip indicates a playback rate of 100 on the right fader. To manually control the playback rate, move the fader to **5**, then move the fader up or down to adjust the rate. If right fader is set at a level other than **10** when you start the cue, *Expression* plays it back at an adjusted rate.

Track

The [Track] feature provides a simple method of *tracking* channels through several cues. Tracked channels are channels in which an intensity level setting is unchanged from the previous cue.

Complete description and instructions on using the [Track] feature begins on page 5 - 9.

Track Sheet

[Track Sheet] displays the Track Sheet mode screen. While in Track Sheet, press [Track Sheet] again to display a second screen of cues, if any. Track Sheet displays level settings of one channel for all recorded cues. The Track Sheet screen is illustrated below. Instructions on working with Track Sheet begin on page 5 - 17.

GRAND MASTER 100% TRACK SHEET CHANNEL 1									
1	2	3	4	5	6	7	8	9	10
FF	00								
11	12	13	14	15	16	17	18	19	20
21	22	23	24	25	26	27	28	29	30
31	32	32.1 FF	32.2 00	32.3 FF	33 00	34	35	36	37
38	39	40	41	42	43	44	45	46	47
48	49	50	51	52	53	54	55	56	57
58	59	60	61	62	63	64	64.1	64.2	64.3
100 FF	101 00	102	111 FF	150 95	200 FF	500 FF	601 00		

SELECT CHANNEL TO BE TRACKED

Type

[Type] displays the fade type options described below. The menu that appears in Stage omits the effect and subroutine options. In subroutines, another fade type (plusfade) is also available.

```

SELECT FADE TYPE
<1 -CROSSFADE, 2 -ALLFADE, 3 -EFFECT, OR 4 -SUBROUTINE>

```

To select a cue fade type in Stage, Blind or Fader modes, press [Type], and enter an option number. If you change a cue's fade type, you must rerecord the cue. If you do not enter a fade type, cue defaults to crossfade.

Crossfade

A crossfade upfades increasing levels as it downfades decreasing levels. Crossfade starts the upfade time when you press [Go]. You can program a wait time between the start of the upfade and downfade.

Allfade/allpart

Allfade forces all unused channels to zero intensity and clears the other fader. When you press [Go] for an allfade cue, all channels except those set at a level above 00 percent in the selected cue are downfaded to 00. Allfade is useful for forcing an end cue when tracking channels. For more information on using allfade for tracking, see page 5 - 15.

Subroutine

A subroutine is a cue that controls the playback of a series of recorded cues. Subroutines are similar to linked cues, except that you have more playback options. See *Chapter 5, Learning advanced techniques* for more information.

Effects

Effects are cues that include a series of steps. Each step includes a set of channels. For more information on effects, see *Chapter 5, Learning advanced techniques*.

Plusfade

Plusfade is available only for subroutines. Only channels included in the subroutine are affected; all other channels remain at previous levels.

Example

[Cue] [1] [Type] [2] [Rec] [Enter] records cue 2 with an allfade.

Update

In Stage mode, [Update] allows you to modify, or add channel levels to, a recorded cue or cue part, submaster or group without recording the entire stage look.

Follow these steps to use [Update] to modify a cue.

1. Press [Stage] to display Stage mode.
2. Select channels, and set levels you want to add.
3. Press [Update].
4. Press [Cue], [Sub] or [Group] then enter cue number.

Note: You need not enter the cue number if it is currently displayed on the cue/submaster description line.

5. Press [Enter].
6. Press [Rel] to release captured channels.

Examples

[Chan] [1] [Thru] [5] [At] [Full] [Update] [Cue] [1] [Enter] [Rel] adds channels 1 through 5, at full intensity, to Cue.

appendix a dip switch settings

DIP switches are located on the back panel of the console. To change the DIP switch settings, remove the clear panel, and set switches. *Expression* reads DIP switch settings when console is turned on. Therefore, if you change any settings, you must reboot console to initialize new settings.

Switches in the down position are off; switches in the up position are on. *Expression* does not use DIP switches A1, A2, and A5. **DIP switch B8 must be Off for the system to boot.**

Messages	A3		
ETC messages	Off		
ARRI messages	On		
CRT AC line frequency	A4		
60 Hz	Off		
50 Hz	On		
Manual readback	A6	A7	A8
None	Off	Off	Off
32 channels	Off	Off	On
64 channels	Off	On	Off
96 channels	Off	On	On
192 channels	On	Off	Off

Analog dimmer outputs	B1	B2
96 wire per dimmer outputs	Off	Off
192 wire per dimmer outputs	Off	On
Strand 192 AMX192 Multiplex outputs	On	Off
Strand 384 AMX192 Multiplex outputs	On	On

Digital dimmer outputs	B3
DMX 512 output	Off
ETC/LMI output	On
Colortran D192 output*	Off

*Remove jumper R and install jumper S. For Revision F circuit boards only, remove jumper C and install jumper D.

Redundant tracking†	B4	B5
Redundant tracking on	On	
Redundant tracking off	Off	
Master console		Off
Slave console		On

†Set printer to parallel

Face panel diagnostics‡	B6
Enabled	On
Disabled	Off

‡Displays timeout message

MIDI Interface	B7
Enabled	On
Disabled	Off

System boot	B8
Enable system boot	Off

appendix b

error messages

Bad sector

Disk in drive has a bad sector. If the console displays this message when you record a show to disk, throw it out and use a new one. Console cannot read shows from a disk with a bad sector. If two shows are on the disk, *Expression might* be able to read the other show.

Configurations differ - Cannot verify

The show you are trying to verify was either 1) configured with different system settings such as numbers of channels or dimmers, or 2) saved from an earlier version of ETC software or a different type of ETC console.

Console configured without a face panel

Indicates that console does not detect an operational face panel. This will occur if your console has been set up to use a Designer's Worksheet, for example, instead of a face panel, or could be caused by a damaged cable linking the face panel to the main processor.

Drive error

Console cannot record to or read from disk because of a disk or drive error. Verify that the disk is formatted and retry operation. If error message recurs, use a new disk.

Drive not responding

Disk drive is not working properly. Try another disk. If error message recurs, contact an authorized dealer or ETC.

Error found in backup memory

The console's memory has been corrupted. When a memory error occurs, you should initiate a diagnostic system clear. Turn console off, press and hold bump switches 7, 8 and 9 down, and turn console back on. Then reload show in console from your backup copy on disk. Memory may be corrupted if console is left off for more than a week or if console is exposed to a static charge.

Error found in dynamic RAM

Indicates hardware error in dynamic memory chip. Please note chip number indicated by the messages and call ETC field service at (608) 831-4116.

Error found in EPROM check sums

Indicates that an EPROM has been corrupted. Console may fail to operate correctly. Please note chip number indicated by the messages and call ETC field service at (608) 831-4116.

Error found in static RAM

Indicates hardware error in battery memory chip. Please note chip number indicated by the messages and call ETC field service at (608) 831-4116.

Error in face panel

Indicates hardware error in face panel memory. Please call ETC field service at (608) 831-4116.

Error in slave processor

Indicates a hardware problem in the slave processor. Please call ETC field service at (608) 831-4116.

Maintenance required

Indicates that your disk drive needs repairs. Contact your authorized dealer or ETC for repairs.

Malfunction in disk drive

Indicates a hardware problem associated with the disk drive. Please call ETC field service at (608) 831-4116.

No cues left

Current show has maximum number of cues recorded. If you need more than 400 cues for your performance, record current show on disk, and write the remaining cues in another show. Then record second show on a disk. To start the performance, read the first show into the console. When you reach the end of show one, read show two from disk into the console for the rest of the performance.

Note: Loading a show from disk stops all fades; therefore, make sure all fades are finished before you load second show.

No disk in disk drive

There is not a disk in drive, or it is improperly inserted in drive. Insert or reinsert disk. Press disk gently until disk snaps into place. Disk ejection button pops out when disk is properly inserted.

Not used

Console does not use this menu option number. Press any key to continue.

Notice

The console has detected an error in the initial boot tests. Please note the error indicated below and consult your user manual.

To continue press Clear.

Console conducts various self tests while the system is booting up. If it detects any errors, the console displays which chips or processors are affected. Please note the error(s) indicated. If this messages occurs, please call ETC field service at (608) 831-4116.

Notice

The main processor has experienced a time out in its communication with the face panel processor.

This may indicate a hardware problem but should not affect the show memory.

Please notify ETC field service at (608) 831-4116 or notify your authorized service center.

This message can be disabled by setting DIP switch B6 in the down position. Please consult your User Manual for further information.

Press clear to continue.

This message indicates that the face panel circuit board and the main processor circuit board have, at least temporarily, experienced a communications error. Such an error is usually caused by a power surge or intermittent line voltage. It might also indicate a hardware problem.

The message is designed to help us diagnose a problem if it recurs. Normally, you can press [Clear] and continue using console without any problems. Console memory is not affected when message is displayed.

If this message occurs frequently, your main console power supply might be out of adjustment. Please call ETC field service if this message occurs often.

You can disable this message by setting DIP switch B6 in the down position.

For more information about DIP switch settings, see *Appendix A, DIP switch settings*.

Optional feature not installed on this system

The option you selected is not installed on this console. Contact your authorized dealer for information about installing options.

Printer is not ready

Your printer is not accepting data. Verify that printer is properly installed and is turned on. Reselect the proper system setting, parallel or serial, for your printer. For printer installation instructions, see *Chapter 2, Installation*.

Record is locked out

Record switch is set at **Lock**. When record switch is in the Lock position, you cannot add, change or delete show information in or from memory. To enable record functions, insert the key provided with console, and turn Record switch to the **On** position.

Selected show not recorded

The show number you selected is not recorded on the disk in drive.

Verify failed

Show recorded on disk is different from the show in console's memory. If you just recorded show to disk, rerecord it. If you get the same error message after the second recording, record show on a new disk.

Write-protected

Console cannot record to disks that are write protected. Insert another disk or close write-protection window on current disk, and retry operation.

appendix c

specifications

Internal interfaces

- Input options
 - Up to 192 0-10V DC analog inputs for readback from manual consoles
 - 0-28V DC also available
- Analog output options
 - Up to 192 0-10V DC dimmer outputs
 - 0-28V DC also available
- Digital output
 - Up to 512 DMX512 digital protocol outputs (1,024 optional)
 - Colortran D192 output
 - LMI digital protocol
 - Kliegl K96 digital protocol (requires optional dimmer interface unit)
- AMX192 output options
 - Up to 384 AMX192 dimmer outputs
- Parallel printer interface
- RS-232C serial port
- Remote Focus Unit interface
- MIDI interface
- Infrared Remote Focus Unit interface
- Remote Submaster panel and Macro panel interfaces
- Remote GO option
- Optically isolated switch inputs for remote control of last 8 macros

Cue capacity

- 400 cues per show
- 2 shows per disk
- 250 control channels
- Proportional softpatching of up to 1,024 DMX512 dimmers
- Multipart cues
- 10 selectable dimmer profiles

Display functions

- One RGB video output
- One monochrome RS-170 CRT video output
- Display modes
 - Flexichannel (with expanded memory option)
 - Stage
 - Blind
 - Fader
 - Submaster
 - Track Sheet
 - Softpatch
 - Set Up
 - Help
 - Submaster sheet
 - Group sheet

Playback controls

- Autofader pairs (2) on 100mm potentiometers
 - .1 second to 99:59 programmable fade times
 - Manual override of upfade and/or downfade
 - Level or proportional rate override
 - Cross fades
 - Pile-on fades
 - Split time fades
 - Manual fades
 - User selectable default fade times
 - Eight-part cues
 - Back function
 - Clear function with user selectable default fade out times

- 24 submaster potentiometers
 - 2 pages of 24 recorded submaster looks
 - Fully overlapping channel assignments
 - Proportional channel levels
 - Bump switch on all 24 submasters
 - Recordable fade and wait times
 - 12 submasters programmable for *inhibitive* operation
 - Update and restore function
- Optional readback from analog console
- Real Time Clock to program up to 10 events for playback on pre-scribed days of the week (optional)
- Grand Master on 100mm potentiometer
- Blackout function

Keyboard functions

- Cue functions
 - Cue function selection for cue numbers .1 to 999.9
 - Clear cues function
 - Fade type selection
 - Fade times, Discrete upfade and downfade times (00:00 - 99:59) for each cue
 - Linked cue sequences
 - Wait time
- Update and restore function
- Optional alphanumeric keyboard

Channel functions

- Channel function to allow channels to be selected by keypad
- Group function to allow channel to be manipulated as proportionally balanced groups
- [And] and [Through] functions for selection of channels, cues and dimmers
- [Full] function with user selectable default level
- Dimmer function to select dimmers in softpatch
- Release function to release captured channels

Macro function

- 125 macro selections for the programming of up to 32 button sequences each (640 macros are available with expanded memory)
- Optional memory expansion card to allow for 640 macros

Effects packages

- Subroutines
- Canned effects
- Simultaneous variability of rate and intensity during playback
- Full variability of rate and intensity during playback

Fader wheel

- Proportional intensity control of channels or groups

Size and weight

- 40 x 15.25 x 6 inches
- 35 pounds

Index

A

Accessories

- alphanumeric keyboard 7-2
- Designer's Worksheet 7-5
- MIDI 7-14
- Real Time Clock 7-18
- Redundant Tracking Backup 7-22
- Remote Focus Unit 7-12
- Serial Button Protocol 7-21

Allfade 5-15, 8-74

Allpart 8-74

- Alphanumeric keyboard 2-18, 4-9, 7-2
 - installing 2-18
 - keyboard type 2-18
 - naming groups with 8-40
 - pinout 2-18

And 8-2

Autoloads 5-2, 5-43, 8-4

in Blind 5-45

in Stage 5-44

playing back 5-46, 8-4, 8-71

B

Back key 4-34, 8-5

Back panel illustration 2-3

Black out 8-6

Blackout cues 5-15

Blind 4-2, 8-7

Boot options 2-7

Bump switches 8-8

enable/disable 3-15

in macros 5-50

recording submasters with 8-9

C

Captured channels 4-6, 8-10

Chan 8-11

Channel display 4-4

Channel modes 4-2, 4-6

Channel zero 3-4

Channels

customizing 3-5

selecting 8-11

Clear 8-13

Clear faders 4-35, 8-15

Clear show from memory 8-16

Clock 7-18

Connectors

dimmers 2-8

Infrared Remote Focus Unit 2-19

keyboard 2-18

monitor 2-5

printer 2-11

Remote Focus Unit 2-16

Console installation 2-3

Crossfade 8-74

Cue 8-17

Cue only 4-8, 8-56

Cue sheet 4-5, 6-4

Cue/submaster description line 4-5

Cues 4-9, 6-3

blackout 5-15

converting regular to multipart 5-3

deleting 4-22, 8-13

displaying in Blind 8-17

displaying in Stage 8-18

go to 4-28

inserting 4-21, 5-13

modifying 5-11

modifying on stage 4-32

Cues (continued...)
 multipart 5-3
 creating 5-3
 definition 5-3
 wait times 5-3
 naming 7-3, 8-19
 numbering 8-19
 playing back 4-25, 4-27
 selecting 4-26
 viewing 4-23

D

Delay time 4-17, 8-20
 Deleting
 cues 4-22, 8-13
 groups 5-25
 submasters 4-47
 Designer's Worksheet 6-5, 7-5, 7-6
 installation 2-13
 programming regions 7-7
 Diagnostic system clear 8-21
 Digitizer 7-5
 Dim 8-22
 Dimmer profiles 3-9, 8-23
 default 3-10
 graphs 8-24
 Dimmers
 AMX-192 2-9
 analog multiplex 2-9
 analog wire-per-dimmer input 2-9
 analog wire-per-dimmer output 2-8
 CD80 2-9
 customizing 3-5
 D192 2-8
 DMX512 2-8
 ETC/LMI 2-8
 installing 2-8
 unpatching 3-11
 Disable bump switches 3-15
 Disk management 6-15
 Disk options
 erase show from disk 6-20
 formatting disk 4-50, 6-16
 reading a show from disk 6-18
 recording a show to disk 4-51, 6-17
 verifying a recorded show 4-52, 6-19
 Display modes 4-2

Displaying
 groups 5-28
 submasters 4-48

E

Effects 5-2, 5-29, 8-74
 bounce 5-29, 8-26
 inserting steps 5-34
 keys 8-26
 loop 5-29, 8-26
 modifiers 5-31
 playing back 8-71
 random 5-29, 8-26
 ripple 5-29, 8-26
 styles 5-29
 Enable bump switches 3-15
 Enter 8-27
 Erase show 6-20
 Error messages A-2
 Except 8-28
 Expand 8-31
 Expanded memory features
 alphanumeric keyboard 7-2
 flexichannel 4-3, 8-35
 Group Sheet 5-28
 group sheet 6-7, 8-41
 keyboard 2-18, 7-2
 naming cues 4-9, 7-3
 naming groups 7-3, 8-40
 naming shows 4-49, 7-4
 naming submasters 4-37, 4-48, 7-3
 Submaster Sheet 4-48, 8-65
 Extending tracks 8-14

F

Fade times 4-15
 submasters 4-41
 Fade types 8-74
 Fader clear time
 default setting 3-15
 Fader display 8-32
 Fader override modes 4-2, 4-30, 8-70
 selecting 4-31
 Fader pairs
 clearing 4-35
 Fader wheel 8-33
 Fader windows 4-5
 Faders 4-30, 8-70

- level override 8-70
- manual 4-29
- proportional rate override 8-70
- using to run
 - autoloads 8-71
 - effects 8-71
 - linked cues 8-71
 - subroutines 8-71
- Features 1-2
- Flash 8-34
- Flexichannel 4-3, 8-35
 - removing channels from display 4-3
- Formatting disks 4-50, 6-16
- Full 8-36
 - setting default 3-14

G

- Getting help 1-6
- Go 8-37
- Go to cue 4-28
- Grand master 8-38
- Group Sheet 6-7, 8-41
- Groups 5-2, 5-21, 6-6, 8-39
 - creating 5-22
 - deleting 5-25
 - displaying 5-22
 - modifying 5-23
 - modifying cues or submasters with 5-27
 - naming 7-3
 - numbering 8-39

H

- Help 8-42
 - customer service 1-6
- Hold 8-43

I

- Infinite submaster wait times 5-50, 8-44, 8-69
- Infrared Remote Focus Unit (IRFU) 7-10
 - enabling 2-19
 - installing 2-19
 - pinout 2-19
- Inhibitive submasters 4-43
 - modifying 4-45
- Inserting cues 4-21, 5-13
- Installation
 - console 2-3

- Designer's Worksheet 2-13
- dimmers 2-8
- Infrared Remote Focus Unit 2-18
- monitor 2-3
- printer 2-10
- Redundant Tracking Backup 2-17
- Remote Focus Unit 2-16
- remote macros 2-20
- remote submasters 2-20

K

- Keyboard. *See* Alphanumeric keyboard
- Keypad prompt window 4-4

L

- Last. *See* Minus (-)
- LED displays 4-26
- Link 8-46
 - cues to cues 4-17
 - cues to macros 8-46

M

- Macros 5-2, 5-47, 6-8, 8-48
 - cancelling 5-51
 - deleting 5-51, 7-9
 - examples 5-52
 - putting on hold 5-50
 - running 5-50
 - submaster bump switches 5-50
 - with expanded memory option 5-47
- Manual fade control
 - submasters 4-42
- MIDI 7-14
 - interfacing with 7-15
 - message definitions 7-17
 - message formats 7-16
- Minus (-) 8-49
- Mode label 4-4
- Modifying groups
 - with Group 5-24
- Modifying submasters with Update 4-46
- Monitor
 - color/monochrome selection 2-6
 - connector 2-5
 - installation 2-3
 - pinout 2-5
 - remote installation 2-4
- Moving channels 4-7
- Multipart cues 5-1, 5-3

Multipart cues (continued...)

- converting regular cues to 5-6
- creating 5-4
- definition 5-3
- editing
 - channels 5-7
 - fade and wait times 5-7
 - wait times 5-3

N

Naming

- cues 4-9, 7-3, 8-19
- groups 7-3, 8-40
- shows 4-49, 7-4
- submasters 4-37, 7-3

Next. *See also* Plus (+)

Numbering cues 8-19

O

Operation modes 4-2

Operator prompt line 4-5

Optional equipment

- alphanumeric keyboard 2-18, 8-19
- Designer's Worksheet 2-13
- Infrared Remote Focus Unit 2-19, 7-10
- Remote Focus Unit 2-16
- remote macros 2-20, 7-24
- remote submasters 2-20, 7-24

P

Page 8-50

- record submaster pages 4-40

Page display 4-5

Pages 4-38

Parallel printer 2-10

Patch 8-52

Pile-on convention 1-5

Pinouts

- dimmers 2-8
- monitor 2-5
- printer 2-11
- Remote Focus Unit 2-16

Playing back cues 4-25, 4-27

Plus (+) 8-53

Plusfade 8-74

- in subroutines 5-39

Potentiometers (Pots) 8-54

Power 8-55

Print options

Cue Sheet 6-4

cues 6-3

Designer's Worksheet 6-5

Group Sheet 6-7

groups 6-6

macros 6-8

Real Time Programs 6-9

Softpatch 6-10

Stage display 6-11

Submaster Sheet 6-13

submasters 6-12

Track Sheet 6-14

Printer

connector 2-11

installing 2-10

pinout 2-11

Programming regions 7-7

Proportional patching 3-8

Proportional rate override 4-26, 4-29,
4-30, 8-70

selecting 4-30, 4-31

R

Real Time Clock

programs 6-9

setting 7-18

Record 8-56

cue only 4-8, 8-56

pile-on submasters 4-39

shows 4-51, 6-17

tracking 4-8

Record (keyed switch) 8-57

Record functions 4-8

Recorded channels 4-7

Recording submasters with bump
switches 8-9

Redundant Tracking Backup 7-22

installation 2-17

pinout 2-17

Rel 8-58

Release captured channels 8-58

Rem dim. *See* Solo

Remote Focus Unit 7-12

connector 2-16

installation 2-16

pinout 2-16

Remote macros 7-24

installing 2-20

pinout 2-20

- Remote submasters 7-24
 - installing 2-20
 - pinout 2-20
- S**
- Save show 4-51
- Selected channels 4-6
- Selecting cues 4-26
- Serial Button Protocol 7-21
- Serial printer 2-10
- Setting defaults
 - dimmer profiles 3-10
 - fade times 3-14
 - fader clear times 3-15
 - Full levels 3-14
- Setting Real Time Clock 7-20
- Setup Menu 8-59
- Shows
 - naming 7-4
- Softpatch 6-10
 - captured channels 3-10
 - channel zero 3-4
 - custom 3-4
 - entering 3-2
 - inhibiting dimmers 3-8
 - one-to-one 3-3
 - patching 3-6
 - proportional 3-8
- Solo 4-19, 8-60
- Stage 4-2, 8-62, 8-63
- Stage display 6-11
- Step/Part 8-63
- Stop. See Hold
- Storing disks 6-16
- Style 5-36
- Sub 8-64
- Submaster Sheet 4-48, 6-7, 6-13, 8-65
- Submaster window 4-5
- Submasters 4-36, 6-12, 8-64
 - copying 4-46
 - deleting 4-47
 - in macros 5-50
 - inhibitive 4-43
 - manual fades 4-42
 - modifying 4-45
 - naming 7-3

- pages of 4-38
- record 4-39
- record to a different page 4-40
- Subroutines 5-36
 - creating 5-37
 - deleting step 5-40
 - inserting step 5-40
 - playing back 8-71
 - plusfade 8-74
- System configuration 2-6
- System Settings Menu 3 - 13, 8-66

T

- Text conventions 1-5
- Thru 8-68
- Time 8-69
- Timed faders 4-26
- Track 5-2, 5-9, 5-10, 8-72
 - allfade 5-15
- Track Sheet 4-3, 5-2, 5-17, 6-14, 8-73
- Tracked channels 4-7
- Tracks
 - extending 8-14
- Type 8-74

U

- Unpatching dimmers 3-11
- Update 4-46, 8-75
 - cues 8-75
 - groups 5-24, 8-75
 - multipart cues 8-75
 - submasters 4-46, 8-75
- Using this manual 1-3

V

- Verify show 4-52, 6-19
- Viewing cues 4-23